

## WENTWORTH™ FAMILY INTERIOR LIGHTING

A Wentworth Family lighting fixture adds turn of the century lighting detail to your home or work place with its distinctive finial. This light fixture family is a good option for hallways, dining rooms, bathrooms and many more interior lighting applications.



NEW  
CLASSICS  
Handmade in USA

# WENTWORTH™ FAMILY

## INTERIOR LIGHTING FIXTURES

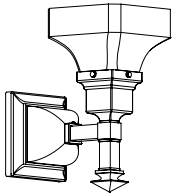

GR-104-B1

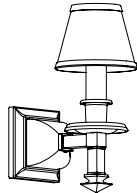

GR-104-B7

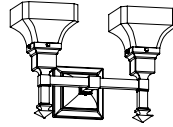

GR-105-B1



GR-105-B7

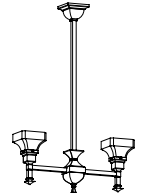

GR-426-B1-09M

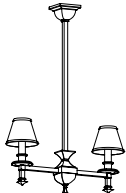

GR-426-B7-09M

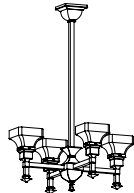

GR-427-B1-09M

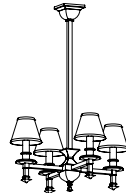

GR-427-B7-09M

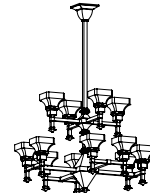

GR-448-B1-09M

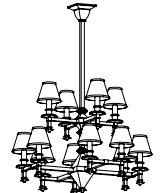

GR-448-B7-09M

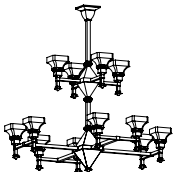

GR-455-B1-09M

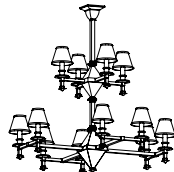

GR-455-B7-09M

brasslightgallery.com 800-243-9595 sales@brasslight.com

Wentworth Family v1.0 page 2

# WENTWORTH™ ONE LIGHT STRAIGHT ARM SCONCE

WITH 2-1/4" SHADE HOLDER

brasslightgallery.com 800-243-9595 sales@brasslight.com

Wentworth Family v1.0 page 3

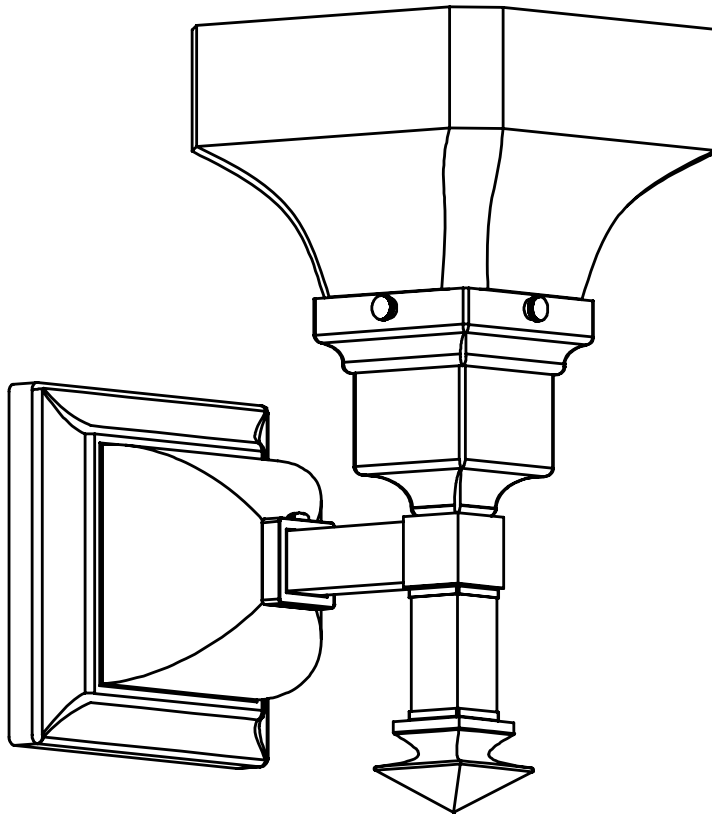

**NEW  
CLASSICS™**  
Handmade in USA

## FINISHES - applied by hand.

Polished Nickel	Architectural Bronze
Brushed Nickel	Verdigris Patina
Black	Distressed Brass
Brushed Brass	Antique Copper
Polished Brass	Satin Antique Brass
Antique Nickel	Unlacquered Pol. Brass
Vintage Nickel	Architectural Iron

## GR-104-B1 Shown with A105 shade(s)

Medium base screw-in socket (1) accepts 150 W max incandescent, compact fluorescent, or LED.

GU24 base bi-pin socket available. 277V 4 pin socket alternative, inquire.

Check our website for alternative 2-1/4" shades.

Mounting plate center mounts to junction box.

Mount glass up or glass down.

UL listed dry location. Damp location available, inquire.

Durably constructed of solid brass.

Made in USA by Brass Light Gallery.

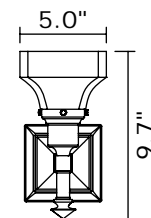
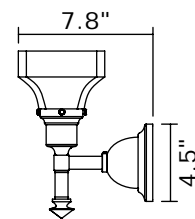

**BRASS LIGHT GALLERY**  
• MILWAUKEE •

© 2013, Brass Light Gallery®

# WENTWORTH™ ONE LIGHT STRAIGHT ARM SCONCE

WITH ELECTRIC CANDLE

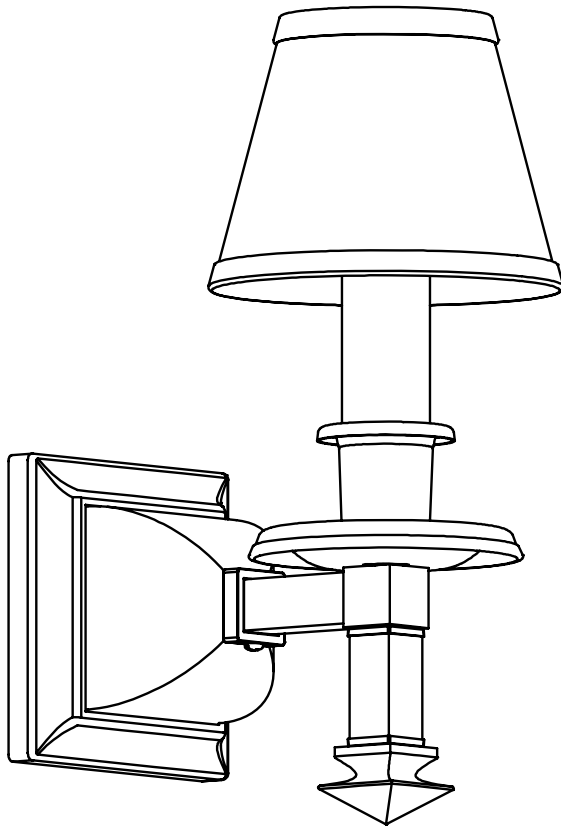

**NEW  
CLASSICS™**  
Handmade in USA

## FINISHES - applied by hand.

Polished Nickel	Architectural Bronze
Brushed Nickel	Verdigris Patina
Black	Distressed Brass
Brushed Brass	Antique Copper
Polished Brass	Satin Antique Brass
Antique Nickel	Unlacquered Pol. Brass
Vintage Nickel	Architectural Iron

## GR-104-B7 Shown with E220 shade(s)

Medium base screw-in socket (1) accepts 60 W max incandescent, compact fluorescent, or LED.

GU24 base bi-pin socket available. 277V 4 pin socket alternative, inquire.

Check online for alternative clip-on shades rated at 40 to 100 watts with this fixture.

Mounting plate center mounts to junction box.

Mount candle up.

UL listed dry location.

Durably constructed of solid brass.

Made in USA by Brass Light Gallery.

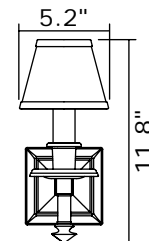
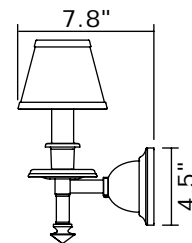

# WENTWORTH™ TWO LIGHT STRAIGHT ARM SCONCE

WITH 2-1/4" SHADE HOLDERS

brasslightgallery.com 800-243-9595 sales@brasslight.com

Wentworth Family v1.0 page 5

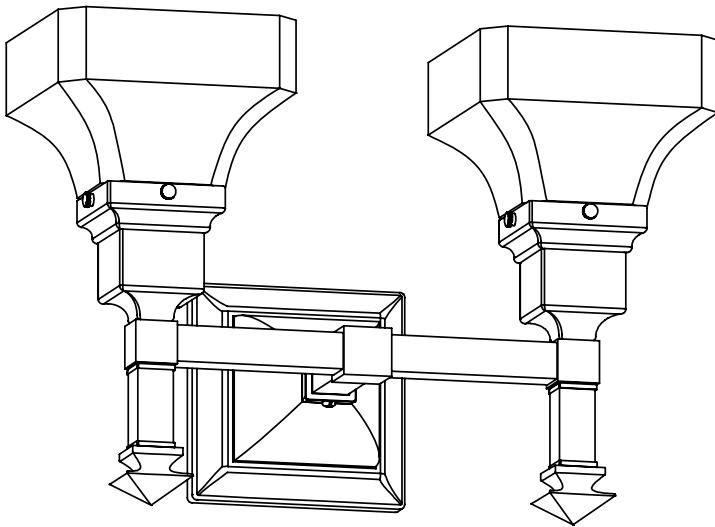

**NEW  
CLASSICS™**  
Handmade in USA

## FINISHES - applied by hand.

Polished Nickel	Architectural Bronze
Brushed Nickel	Verdigris Patina
Black	Distressed Brass
Brushed Brass	Antique Copper
Polished Brass	Satin Antique Brass
Antique Nickel	Unlacquered Pol. Brass
Vintage Nickel	Architectural Iron

## GR-105-B1 Shown with A105 shade(s)

Medium base screw-in sockets (2) each accept 150 W max incandescent, compact fluorescent, or LED.

GU24 base bi-pin socket available. 277V 4 pin socket alternative, inquire.

Check our website for alternative 2-1/4" shades.

Mounting plate center mounts to junction box.

Mount glass up or glass down.

UL listed dry location. Damp location available, inquire.

Durably constructed of solid brass.

Made in USA by Brass Light Gallery.

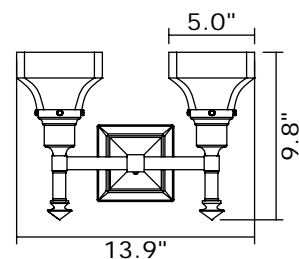
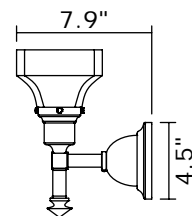

**BRASS LIGHT GALLERY**  
• MILWAUKEE •

© 2013, Brass Light Gallery®

# WENTWORTH™ TWO LIGHT STRAIGHT ARM SCONCE

WITH ELECTRIC CANDLES

brasslightgallery.com 800-243-9595 sales@brasslight.com

Wentworth Family v1.0 page 6



**NEW  
CLASSICS™**  
Handmade in USA

## FINISHES - applied by hand.

Polished Nickel	Architectural Bronze
Brushed Nickel	Verdigris Patina
Black	Distressed Brass
Brushed Brass	Antique Copper
Polished Brass	Satin Antique Brass
Antique Nickel	Unlacquered Pol. Brass
Vintage Nickel	Architectural Iron

## GR-105-B7 Shown with E220 shade(s)

Medium base screw-in sockets (2) each accept 60 W max incandescent, compact fluorescent, or LED.

GU24 base bi-pin socket available. 277V 4 pin socket alternative, inquire.

Check online for alternative clip-on shades rated at 40 to 100 watts with this fixture.

Mounting plate center mounts to junction box.

Mount candle up.

UL listed dry location.

Durably constructed of solid brass.

Made in USA by Brass Light Gallery.

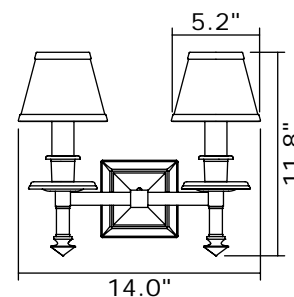
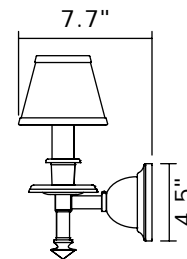

**BRASS LIGHT GALLERY**  
• MILWAUKEE •

© 2013, Brass Light Gallery®

# WENTWORTH™ TWO LIGHT CHANDELIER

WITH 2-1/4" SHADE HOLDERS

brasslightgallery.com 800-243-9595 sales@brasslight.com

Wentworth Family v1.0 page 7

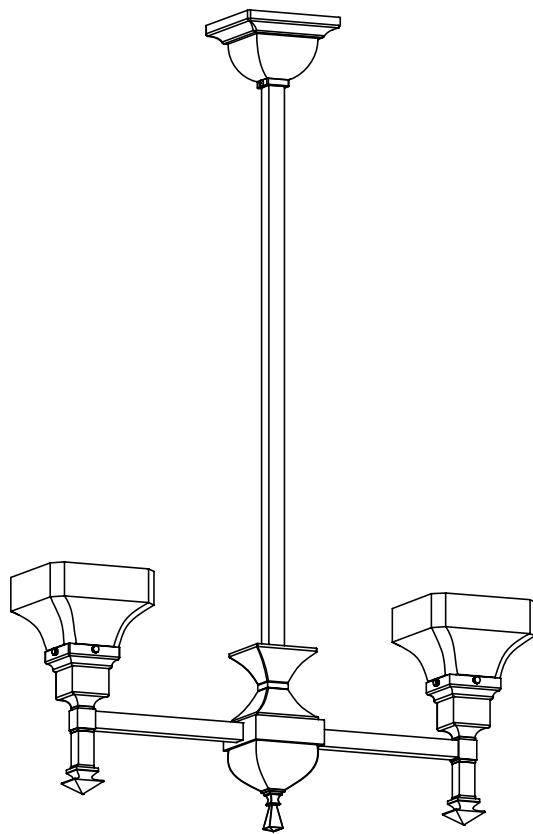

**NEW CLASSICS™**  
Handmade in USA

## FINISHES - applied by hand.

Polished Nickel	Architectural Bronze
Brushed Nickel	Verdigris Patina
Black	Distressed Brass
Brushed Brass	Antique Copper
Polished Brass	Satin Antique Brass
Antique Nickel	Unlacquered Pol. Brass
Vintage Nickel	Architectural Iron

## GR-426-B1-09M Shown with A105 shade(s)

Medium base screw-in sockets (2) each accept 150 W max incandescent, compact fluorescent, or LED.

GU24 base bi-pin socket available. 277V 4 pin socket alternative, inquire.

Check our website for alternative 2-1/4" shades.

Mounting plate center mounts to junction box.

Specify overall length. Minimum overall length 15".

Angled ceiling version available, inquire.

UL listed dry location.

Durably constructed of solid brass.

Made in USA by Brass Light Gallery.

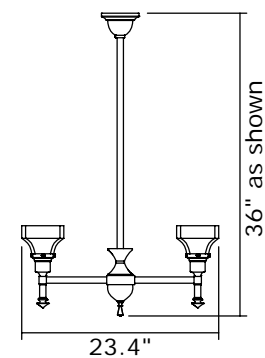
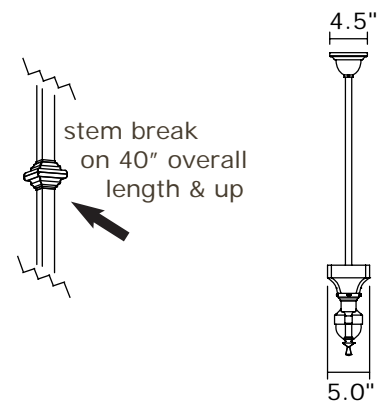

**BRASS LIGHT GALLERY**  
• MILWAUKEE •

© 2013, Brass Light Gallery®

# WENTWORTH™ TWO LIGHT CHANDELIER

WITH ELECTRIC CANDLES

brasslightgallery.com 800-243-9595 sales@brasslight.com

Wentworth Family v1.0 page 8

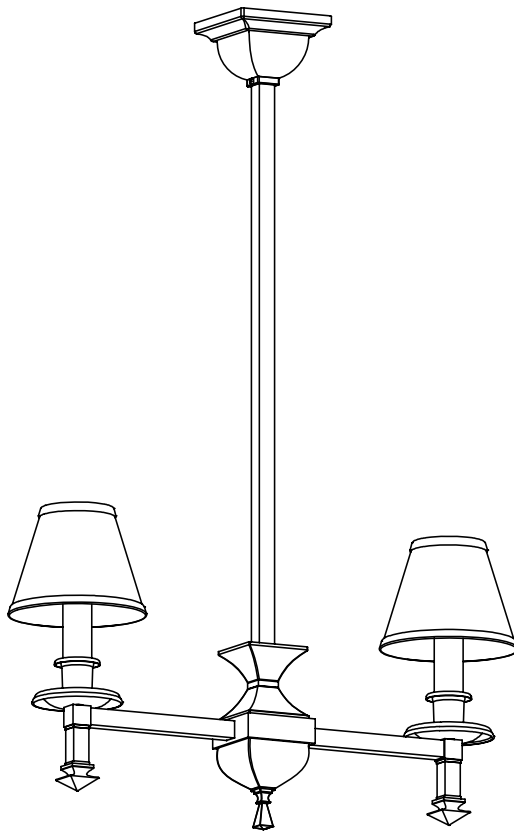

**NEW CLASSICS™**  
Handmade in USA

## FINISHES - applied by hand.

Polished Nickel	Architectural Bronze
Brushed Nickel	Verdigris Patina
Black	Distressed Brass
Brushed Brass	Antique Copper
Polished Brass	Satin Antique Brass
Antique Nickel	Unlacquered Pol. Brass
Vintage Nickel	Architectural Iron

## GR-426-B7-09M Shown with E210 shade(s)

Medium base screw-in sockets (2) each accept 60 W max incandescent, compact fluorescent, or LED.

GU24 base bi-pin socket available. 277V 4 pin socket alternative, inquire.

Check online for alternative clip-on shades rated at 40 to 100 watts with this fixture.

Mounting plate center mounts to junction box.

Specify overall length. Minimum overall length 18".

Angled ceiling version available, inquire.

UL listed dry location.

Durably constructed of solid brass.

Made in USA by Brass Light Gallery.

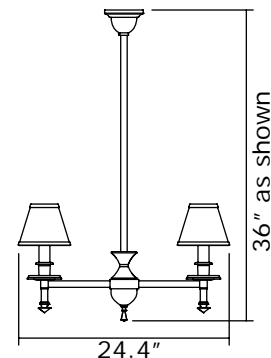
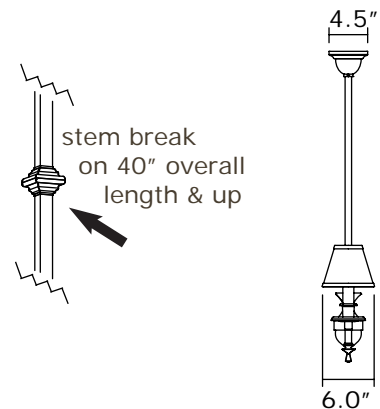

**BRASS LIGHT GALLERY**  
• MILWAUKEE •

© 2013, Brass Light Gallery®



# WENTWORTH™ FOUR LIGHT CHANDELIER

WITH 2-1/4" SHADE HOLDERS

brasslightgallery.com 800-243-9595 sales@brasslight.com

Wentworth Family v1.0 page 9

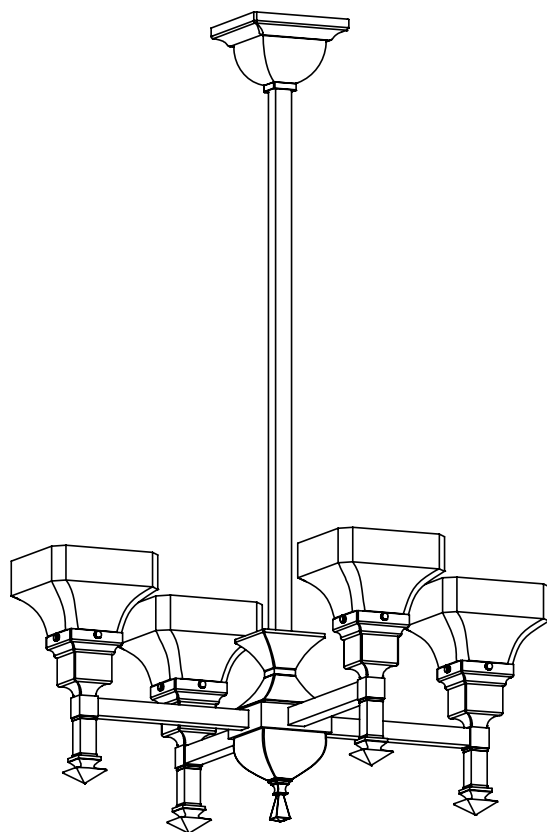

**NEW CLASSICS™**  
Handmade in USA

## FINISHES - applied by hand.

Polished Nickel	Architectural Bronze
Brushed Nickel	Verdigris Patina
Black	Distressed Brass
Brushed Brass	Antique Copper
Polished Brass	Satin Antique Brass
Antique Nickel	Unlacquered Pol. Brass
Vintage Nickel	Architectural Iron

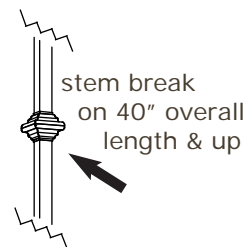

## GR-427-B1-09M Shown with A105 shade(s)

Medium base screw-in sockets (4) each accept 150 W max incandescent, compact fluorescent, or LED.

GU24 base bi-pin socket available. 277V 4 pin socket alternative, inquire.

Check our website for alternative 2-1/4" shades.

Mounting plate center mounts to junction box.

Specify overall length. Minimum overall length 15".

Angled ceiling version available, inquire.

UL listed dry location.

Durably constructed of solid brass.

Made in USA by Brass Light Gallery.

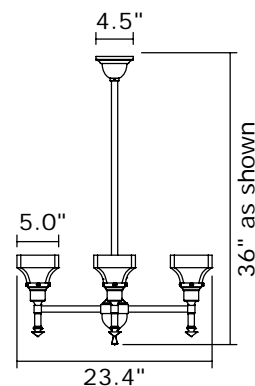

**BRASS LIGHT GALLERY**  
• MILWAUKEE •

© 2013, Brass Light Gallery®

# WENTWORTH™ FOUR LIGHT CHANDELIER

WITH ELECTRIC CANDLES

brasslightgallery.com 800-243-9595 sales@brasslight.com

Wentworth Family v1.0 page 10

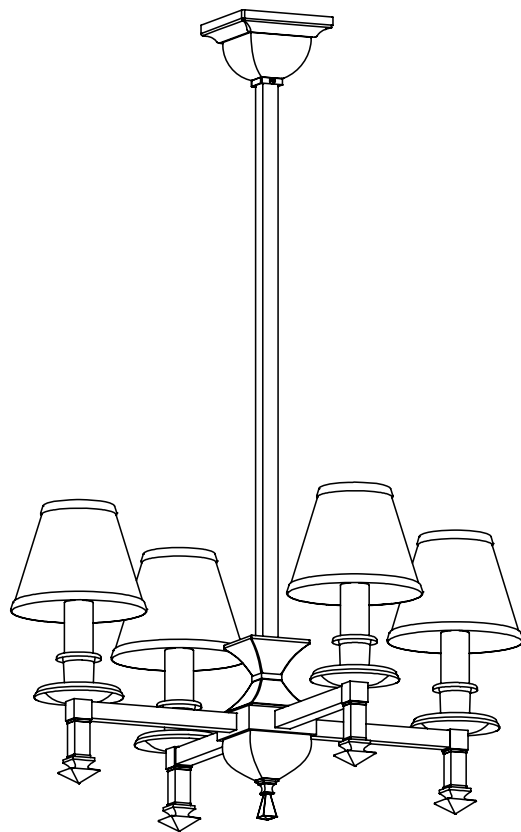

**NEW CLASSICS™**  
Handmade in USA

## FINISHES - applied by hand.

Polished Nickel	Architectural Bronze
Brushed Nickel	Verdigris Patina
Black	Distressed Brass
Brushed Brass	Antique Copper
Polished Brass	Satin Antique Brass
Antique Nickel	Unlacquered Pol. Brass
Vintage Nickel	Architectural Iron

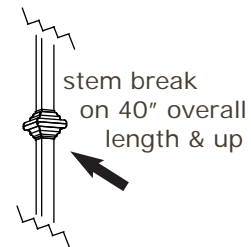

## GR-427-B7-09M Shown with E210 shade(s)

Medium base screw-in sockets (4) each accept 60 W max incandescent, compact fluorescent, or LED.

GU24 base bi-pin socket available. 277V 4 pin socket alternative, inquire.

Check online for alternative clip-on shades rated at 40 to 100 watts with this fixture.

Mounting plate center mounts to junction box.

Specify overall length. Minimum overall length 18".

Angled ceiling version available, inquire.

UL listed dry location.

Durably constructed of solid brass.

Made in USA by Brass Light Gallery.

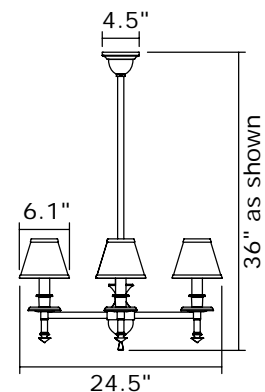

**BRASS LIGHT GALLERY**  
• MILWAUKEE •

© 2013, Brass Light Gallery®

# WENTWORTH™ TWELVE LIGHT TWO TIER CHANDELIER

WITH 2-1/4" SHADE HOLDERS

brasslightgallery.com 800-243-9595 sales@brasslight.com

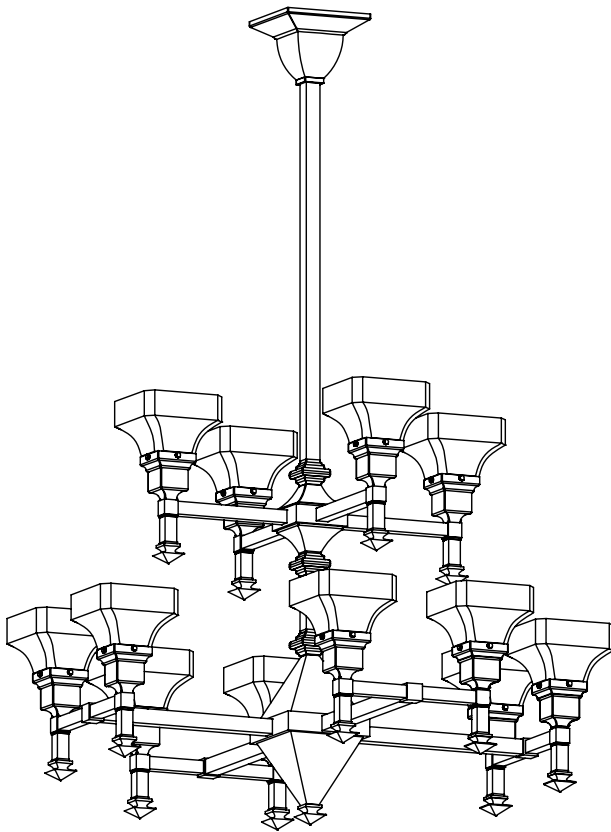

**NEW CLASSICS™**  
Handmade in USA

## FINISHES - applied by hand.

Polished Nickel	Architectural Bronze
Brushed Nickel	Verdigris Patina
Black	Distressed Brass
Brushed Brass	Antique Copper
Polished Brass	Satin Antique Brass
Antique Nickel	Unlacquered Pol. Brass
Vintage Nickel	Architectural Iron

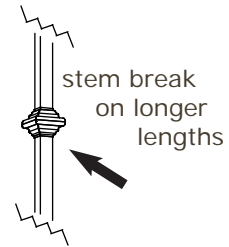

## GR-448-B1-09M Shown with A105 shade(s)

Medium base screw-in sockets (12) each accept 150 W max incandescent, compact fluorescent, or LED.

GU24 base bi-pin socket available. 277V 4 pin socket alternative, inquire.

Check our website for alternative 2-1/4" shades.

Mounting plate center mounts to junction box.

Specify overall length. Minimum overall length 28".

Angled ceiling version available, inquire.

UL listed dry location.

Durably constructed of solid brass.

Made in USA by Brass Light Gallery.

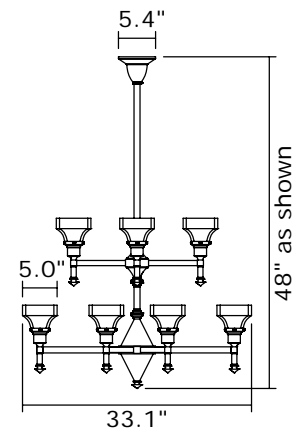

Wentworth Family v1.0 page 11

# WENTWORTH™ TWELVE LIGHT TWO TIER CHANDELIER

WITH ELECTRIC CANDLES

brasslightgallery.com 800-243-9595 sales@brasslight.com

Wentworth Family v1.0 page 12

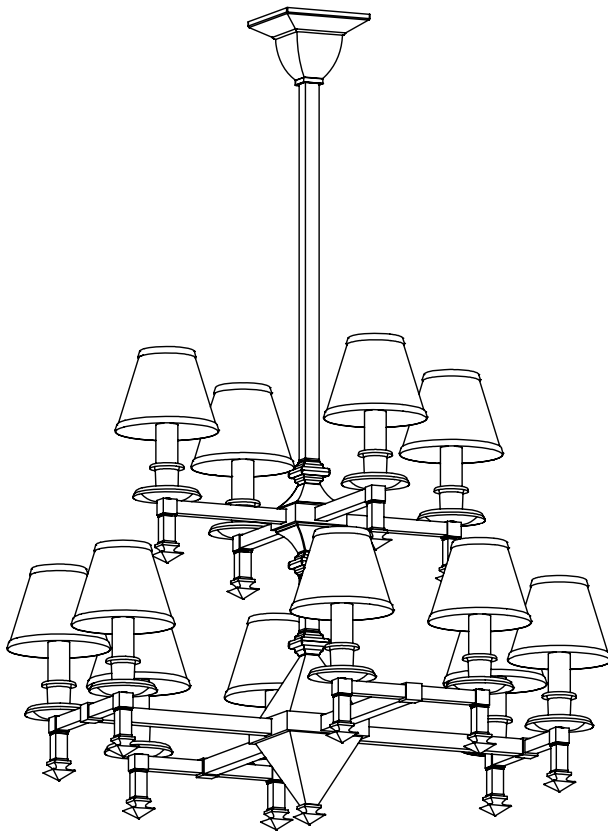

**NEW CLASSICS™**  
Handmade in USA

## FINISHES - applied by hand.

Polished Nickel	Architectural Bronze
Brushed Nickel	Verdigris Patina
Black	Distressed Brass
Brushed Brass	Antique Copper
Polished Brass	Satin Antique Brass
Antique Nickel	Unlacquered Pol. Brass
Vintage Nickel	Architectural Iron

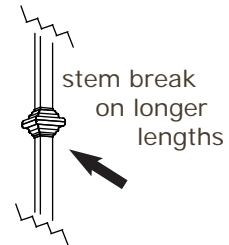

## GR-448-B7-09M Shown with E210 shade(s)

Medium base screw-in sockets (12) each accept 60 W max incandescent, compact fluorescent, or LED.

GU24 base bi-pin socket available. 277V 4 pin socket alternative, inquire.

Check online for alternative clip-on shades rated at 40 to 100 watts with this fixture.

Mounting plate center mounts to junction box.

Specify overall length. Minimum overall length 29".

Angled ceiling version available, inquire.

UL listed dry location.

Durably constructed of solid brass.

Made in USA by Brass Light Gallery.

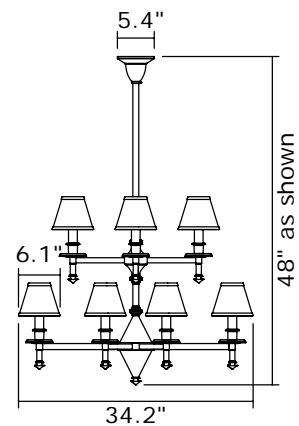

# WENTWORTH™ TWELVE LIGHT LARGE TWO TIER CHANDELIER

WITH 2-1/4" SHADE HOLDERS

brasslightgallery.com 800-243-9595 sales@brasslight.com

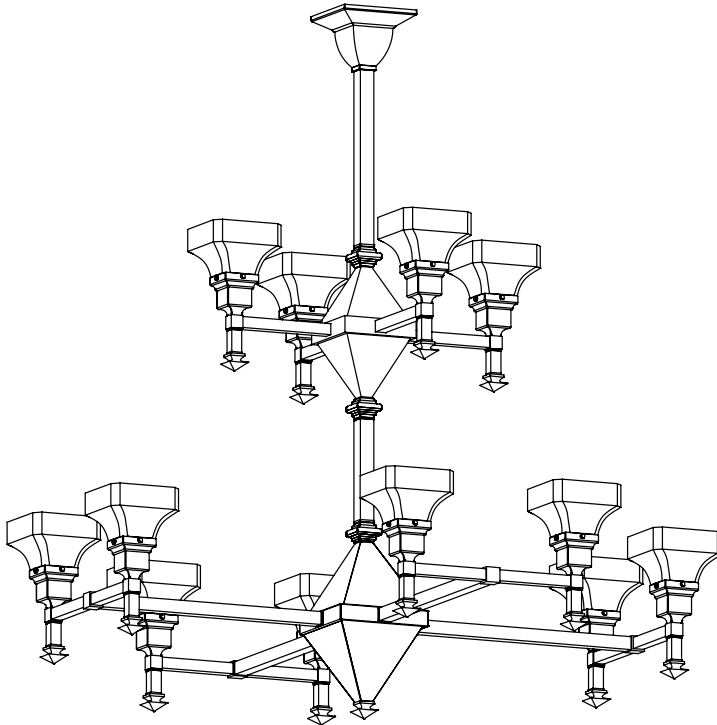

## FINISHES - applied by hand.

Polished Nickel	Architectural Bronze
Brushed Nickel	Verdigris Patina
Black	Distressed Brass
Brushed Brass	Antique Copper
Polished Brass	Satin Antique Brass
Antique Nickel	Unlacquered Pol. Brass
Vintage Nickel	Architectural Iron

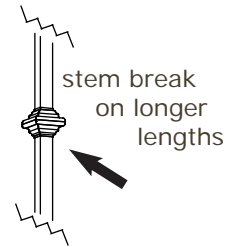

## GR-455-B1-09M Shown with A105 shade(s)

Medium base screw-in sockets (12) each accept 150 W max incandescent, compact fluorescent, or LED.

GU24 base bi-pin socket available. 277V 4 pin socket alternative, inquire.

Check our website for alternative 2-1/4" shades.

Mounting plate center mounts to junction box.

Specify overall length. Minimum overall length 39".

Angled ceiling version available, inquire.

UL listed dry location.

Durably constructed of solid brass.

Made in USA by Brass Light Gallery.

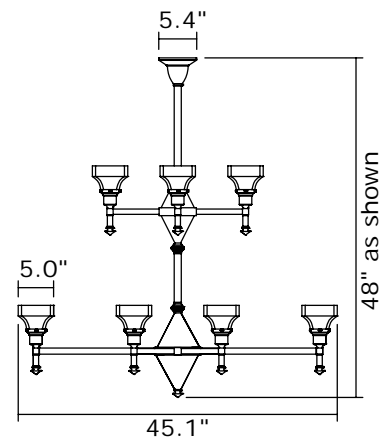

Wentworth Family v1.0 page 13

# WENTWORTH™ TWELVE LIGHT LARGE TWO TIER CHANDELIER

## WITH ELECTRIC CANDLES

brasslightgallery.com 800-243-9595 sales@brasslight.com

**NEW CLASSICS™**  
Handmade in USA

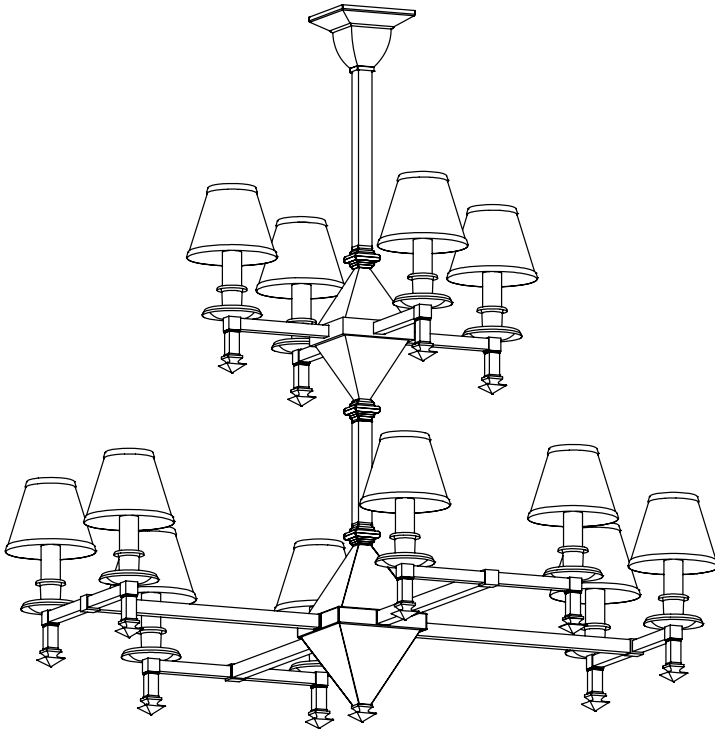

### FINISHES - applied by hand.

Polished Nickel	Architectural Bronze
Brushed Nickel	Verdigris Patina
Black	Distressed Brass
Brushed Brass	Antique Copper
Polished Brass	Satin Antique Brass
Antique Nickel	Unlacquered Pol. Brass
Vintage Nickel	Architectural Iron

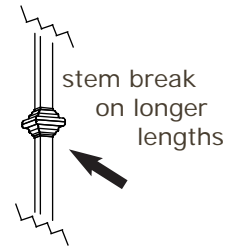

### GR-455-B7-09M Shown with E210 shade(s)

Medium base screw-in sockets (12) each accept 60 W max incandescent, compact fluorescent, or LED.

GU24 base bi-pin socket available. 277V 4 pin socket alternative, inquire.

Check online for alternative clip-on shades rated at 40 to 100 watts with this fixture.

Mounting plate center mounts to junction box.

Specify overall length. Minimum overall length 39".

Angled ceiling version available, inquire.

UL listed dry location.

Durably constructed of solid brass.

Made in USA by Brass Light Gallery.

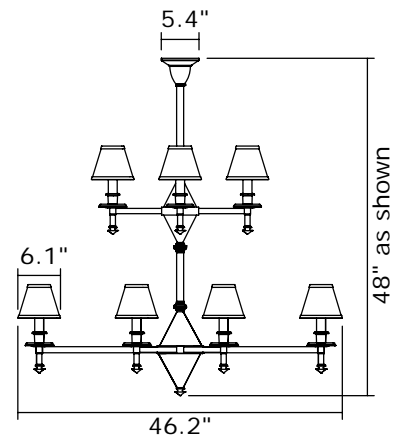

Wentworth Family v1.0 page 14