

PROVENCE™ FAMILY

Lighting originally designed for a popular European resort, the Provence Family is equally at home in formal or casual interior lighting settings. Most chandeliers, pendants, and sconces include reeded brass stems, cast rosettes and curled arms.



NEW
CLASSICS™
Handmade in USA

PROVENCE™ FAMILY

INTERIOR LIGHTING FIXTURES

brasslightgallery.com 800-243-9595 sales@brasslight.com

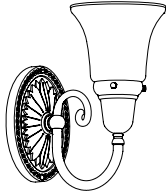

CN-130-A4

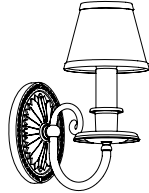

CN-130-B7



CN-131-A4

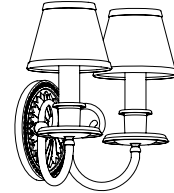

CN-131-B7

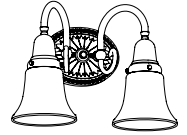

CN-132-A4

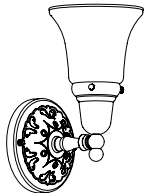

CN-160-A4

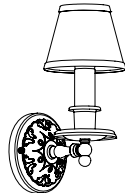

CN-160-B7



CN-161-A4



CN-401-A4-01M



CN-401-A5-01M



CN-412-A4-03M

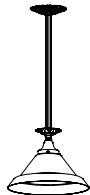

CN-412-A5-03M

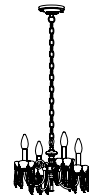

CN-438-B2-05M

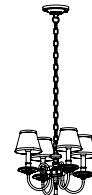

CN-438-E4-05M

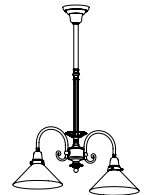

CN-460-A4-03M

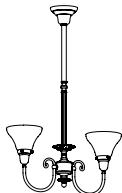

CN-460-A4-09M

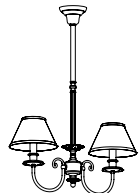

CN-460-B7-09M

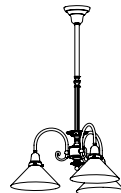

CN-462-A4-03M



CN-462-A4-09M

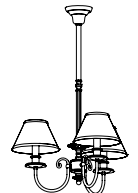

CN-462-B7-09M

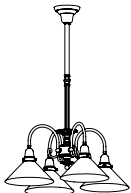

CN-464-A4-03M



CN-464-A4-09M

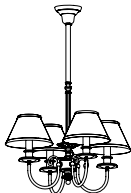

CN-464-B7-09M

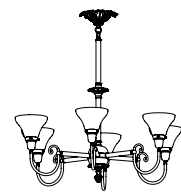

CN-490-A4-10M

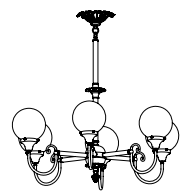

CN-490-A5-10M



CN-490-B7-10M

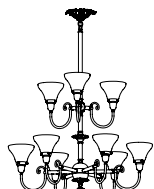

CN-491-A4-10M

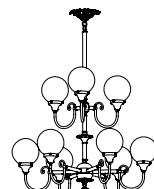

CN-491-A5-10M

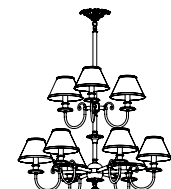

CN-491-B7-10M

Provence Family v1.0 page 2

PROVENCE™ ONE LIGHT CURVED ARM SCONCE

WITH 2-1/4" SHADE HOLDER

brasslightgallery.com 800-243-9595 sales@brasslight.com

Provence Family v1.0 page 3

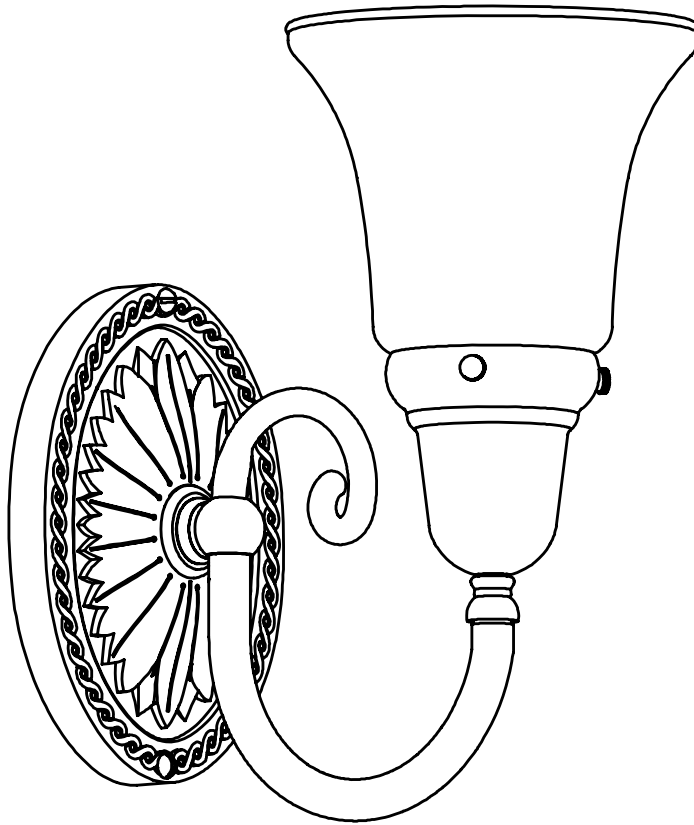

**NEW
CLASSICS™**
Handmade in USA

FINISHES - applied by hand.

Polished Nickel	Architectural Bronze
Brushed Nickel	Verdigris Patina
Black	Distressed Brass
Brushed Brass	Antique Copper
Polished Brass	Satin Antique Brass
Antique Nickel	Unlacquered Pol. Brass
Vintage Nickel	Architectural Iron

CN-130-A4 Shown with A151 shade(s)

Medium base screw-in socket (1) accepts 150 W max incandescent, compact fluorescent, or LED.

GU24 base bi-pin socket available. 277V 4 pin socket alternative, inquire.

Check our website for alternative 2-1/4" shades.

Mounting plate center mounts to junction box.

Mount glass up or glass down.

UL listed dry location. Damp location available, inquire.

Durably constructed of solid brass.

Made in USA by Brass Light Gallery.

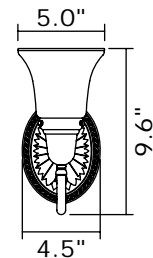
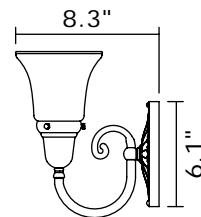

BRASS LIGHT GALLERY
• MILWAUKEE •

© 2012, Brass Light Gallery®

PROVENCE™ ONE LIGHT CURVED ARM SCONCE

WITH ELECTRIC CANDLE

brasslightgallery.com 800-243-9595 sales@brasslight.com

Provence Family v1.0 page 4

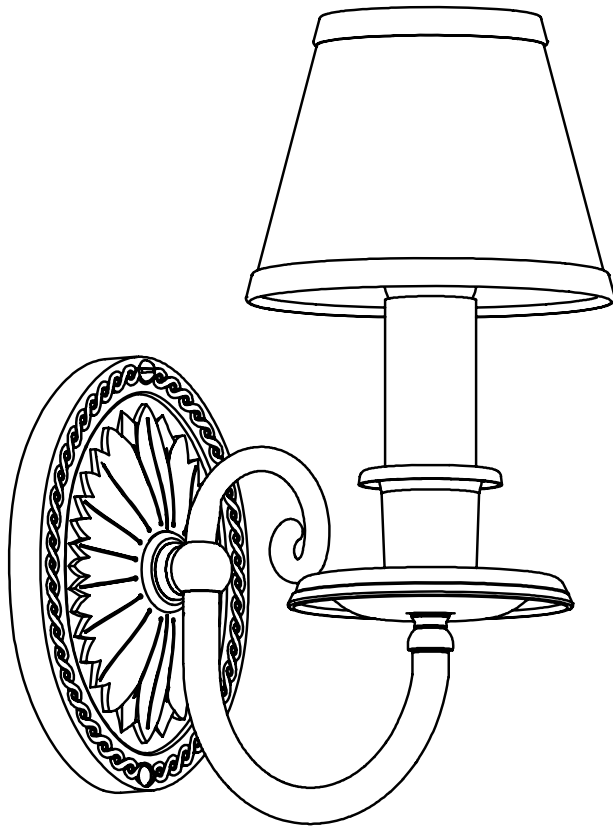

**NEW
CLASSICS™**
Handmade in USA

FINISHES - applied by hand.

Polished Nickel	Architectural Bronze
Brushed Nickel	Verdigris Patina
Black	Distressed Brass
Brushed Brass	Antique Copper
Polished Brass	Satin Antique Brass
Antique Nickel	Unlacquered Pol. Brass
Vintage Nickel	Architectural Iron

CN-130-B7 Shown with E220 shade(s)

Medium base screw-in socket (1) accepts 60 W max incandescent, compact fluorescent, or LED.

GU24 base bi-pin socket available. 277V 4 pin socket alternative, inquire.

Check online for alternative clip-on shades rated at 40 to 100 watts with this fixture.

Mounting plate center mounts to junction box.

Mount candle up.

UL listed dry location.

Durably constructed of solid brass.

Made in USA by Brass Light Gallery.

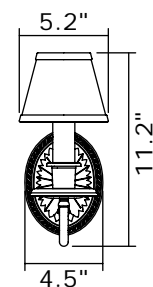
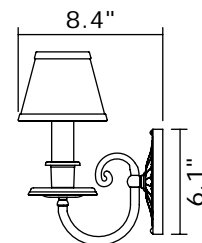

BRASS LIGHT GALLERY
• MILWAUKEE •

© 2012, Brass Light Gallery®

PROVENCE™ TWO LIGHT CURVED ARM SCONCE

WITH 2-1/4" SHADE HOLDERS

brasslightgallery.com 800-243-9595 sales@brasslight.com

Provence Family v1.0 page 5

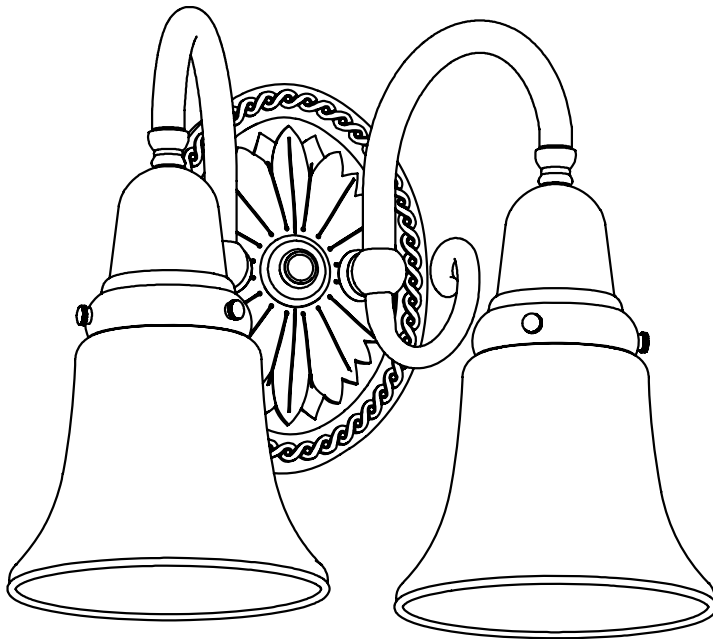

**NEW
CLASSICS™**
Handmade in USA

FINISHES - applied by hand.

Polished Nickel	Architectural Bronze
Brushed Nickel	Verdigris Patina
Black	Distressed Brass
Brushed Brass	Antique Copper
Polished Brass	Satin Antique Brass
Antique Nickel	Unlacquered Pol. Brass
Vintage Nickel	Architectural Iron

CN-131-A4 Shown with A151 shade(s)

Medium base screw-in sockets (2) each accept 150 W max incandescent, compact fluorescent, or LED.

GU24 base bi-pin socket available. 277V 4 pin socket alternative, inquire.

Check our website for alternative 2-1/4" shades.

Mounting plate center mounts to junction box.

Mount glass up or glass down.

UL listed dry location. Damp location available, inquire.

Durably constructed of solid brass.

Made in USA by Brass Light Gallery.

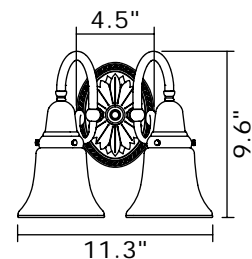
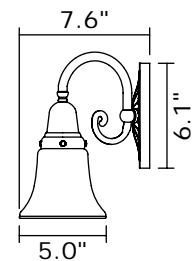

PROVENCE™ TWO LIGHT CURVED ARM SCONCE

WITH ELECTRIC CANDLES

brasslightgallery.com 800-243-9595 sales@brasslight.com

Provence Family v1.0 page 6

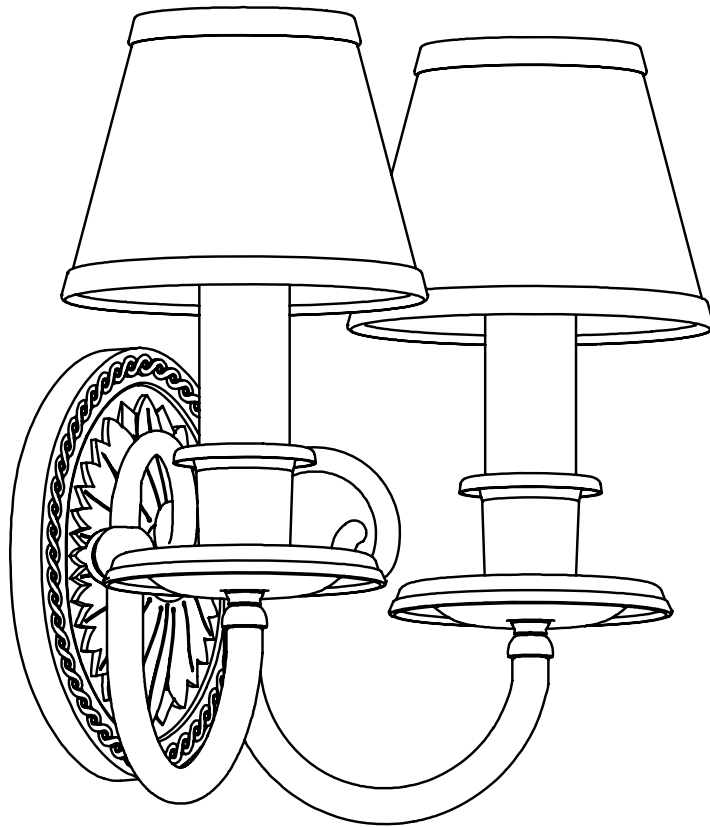

**NEW
CLASSICS™**
Handmade in USA

FINISHES - applied by hand.

Polished Nickel	Architectural Bronze
Brushed Nickel	Verdigris Patina
Black	Distressed Brass
Brushed Brass	Antique Copper
Polished Brass	Satin Antique Brass
Antique Nickel	Unlacquered Pol. Brass
Vintage Nickel	Architectural Iron

CN-131-B7 Shown with E220 shade(s)

Medium base screw-in sockets (2) each accept 60 W max incandescent, compact fluorescent, or LED.

GU24 base bi-pin socket available. 277V 4 pin socket alternative, inquire.

Check online for alternative clip-on shades rated at 40 to 100 watts with this fixture.

Mounting plate center mounts to junction box.

Mount candle up.

UL listed dry location.

Durably constructed of solid brass.

Made in USA by Brass Light Gallery.

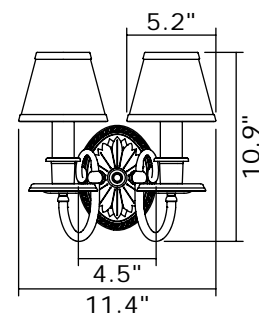
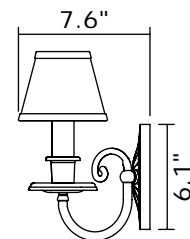

BRASS LIGHT GALLERY
• MILWAUKEE •

© 2012, Brass Light Gallery®

PROVENCE™ TWO LIGHT WATERFALL SCONCE

WITH 2-1/4" SHADE HOLDERS

brasslightgallery.com 800-243-9595 sales@brasslight.com

Provence Family v1.0 page 7

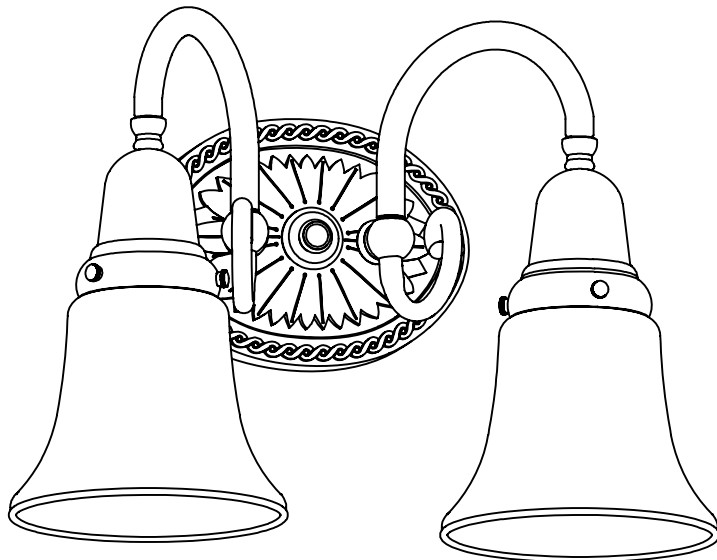

NEW
CLASSICS™
Handmade in USA

FINISHES - applied by hand.

Polished Nickel	Architectural Bronze
Brushed Nickel	Verdigris Patina
Black	Distressed Brass
Brushed Brass	Antique Copper
Polished Brass	Satin Antique Brass
Antique Nickel	Unlacquered Pol. Brass
Vintage Nickel	Architectural Iron

CN-132-A4 Shown with A151 shade(s)

Medium base screw-in sockets (2) each accept 150 W max incandescent, compact fluorescent, or LED.

GU24 base bi-pin socket available. 277V 4 pin socket alternative, inquire.

Check our website for alternative 2-1/4" shades.

Mounting plate center mounts to junction box.

Mount glass up or glass down.

UL listed dry location. Damp location available, inquire.

Durably constructed of solid brass.

Made in USA by Brass Light Gallery.

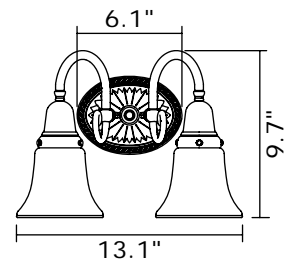
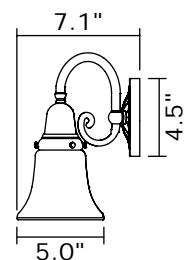

PROVENCE™ ONE LIGHT STRAIGHT ARM SCONCE

WITH 2-1/4" SHADE HOLDER

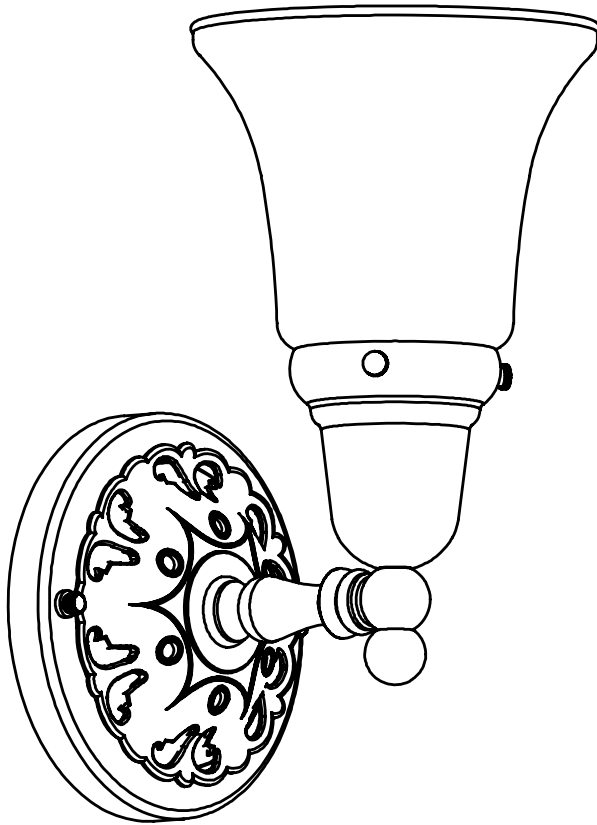

**NEW
CLASSICS™**
Handmade in USA

FINISHES - applied by hand.

Polished Nickel	Architectural Bronze
Brushed Nickel	Verdigris Patina
Black	Distressed Brass
Brushed Brass	Antique Copper
Polished Brass	Satin Antique Brass
Antique Nickel	Unlacquered Pol. Brass
Vintage Nickel	Architectural Iron

CN-160-A4 Shown with A151 shade(s)

Medium base screw-in socket (1) accepts 150 W max incandescent, compact fluorescent, or LED.

GU24 base bi-pin socket available. 277V 4 pin socket alternative, inquire.

Check our website for alternative 2-1/4" shades.

Mounting plate center mounts to junction box.

Mount glass up or glass down.

UL listed dry location. Damp location available, inquire.

Durably constructed of solid brass.

Made in USA by Brass Light Gallery.

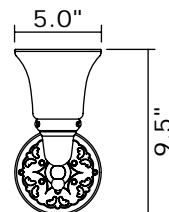
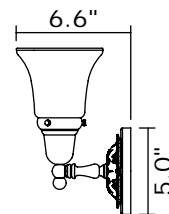

PROVENCE™ ONE LIGHT STRAIGHT ARM SCONCE

WITH ELECTRIC CANDLE

brasslightgallery.com 800-243-9595 sales@brasslight.com

Provence Family v1.0 page 9

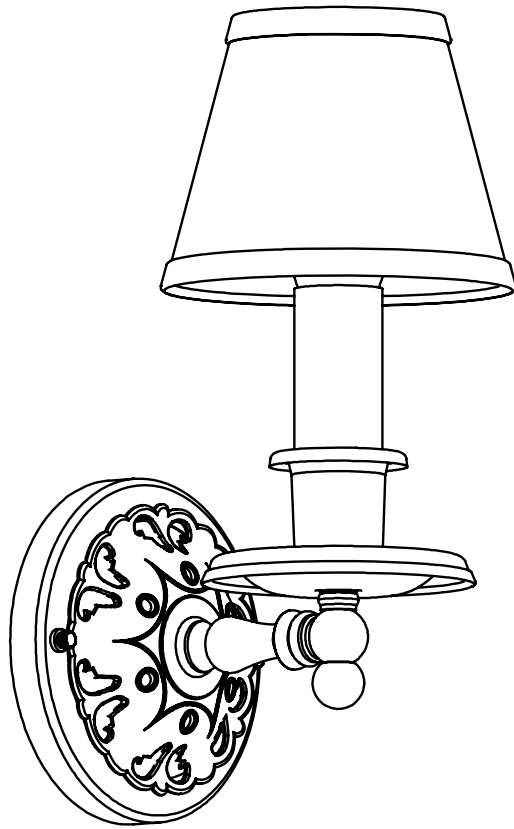

NEW
CLASSICS™
Handmade in USA

FINISHES - applied by hand.

Polished Nickel	Architectural Bronze
Brushed Nickel	Verdigris Patina
Black	Distressed Brass
Brushed Brass	Antique Copper
Polished Brass	Satin Antique Brass
Antique Nickel	Unlacquered Pol. Brass
Vintage Nickel	Architectural Iron

CN-160-B7 Shown with E220 shade(s)

Medium base screw-in socket (1) accepts 60 W max incandescent, compact fluorescent, or LED.

GU24 base bi-pin socket available. 277V 4 pin socket alternative, inquire.

Check online for for alternative clip-on shades rated at 40 to 60 watts with this fixture.

Mounting plate center mounts to junction box.

Mount candle up.

UL listed dry location.

Durably constructed of solid brass.

Made in USA by Brass Light Gallery.

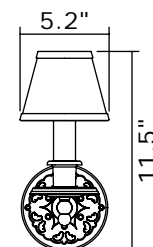
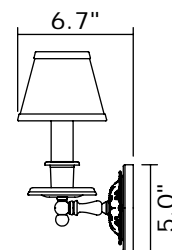

BRASS LIGHT GALLERY
• MILWAUKEE •

© 2012, Brass Light Gallery®

PROVENCE™ ONE LIGHT LARGE CURVED ARM SCONCE

WITH 2-1/4" SHADE HOLDER

brasslightgallery.com 800-243-9595 sales@brasslight.com

Provence Family v1.0 page 10

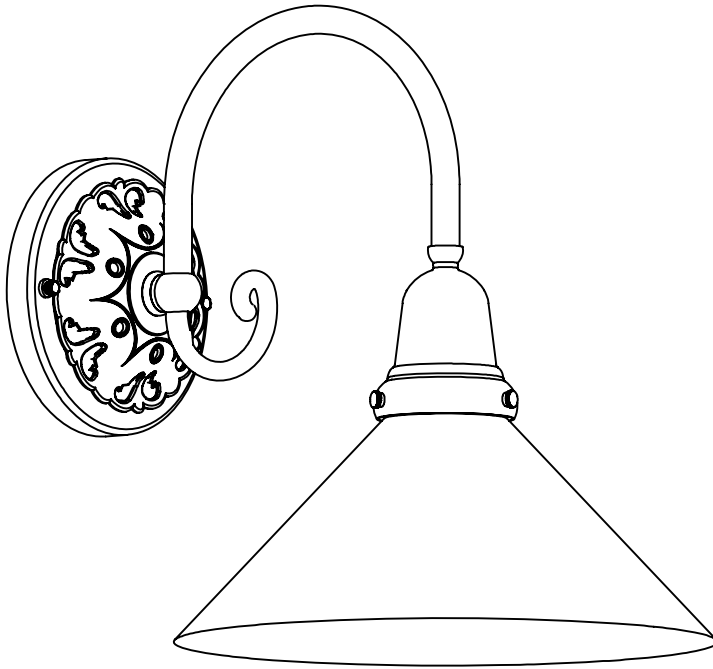

**NEW
CLASSICS™**
Handmade in USA

FINISHES - applied by hand.

Polished Nickel	Architectural Bronze
Brushed Nickel	Verdigris Patina
Black	Distressed Brass
Brushed Brass	Antique Copper
Polished Brass	Satin Antique Brass
Antique Nickel	Unlacquered Pol. Brass
Vintage Nickel	Architectural Iron

CN-161-A4 Shown with A156 shade(s)

Medium base screw-in socket (1) accepts 150 W max incandescent, compact fluorescent, or LED.

GU24 base bi-pin socket available. 277V 4 pin socket alternative, inquire.

Check our website for alternative 2-1/4" shades.

Mounting plate center mounts to junction box.

Mount glass up or glass down.

UL listed dry location. Damp location available, inquire.

Durably constructed of solid brass.

Made in USA by Brass Light Gallery.

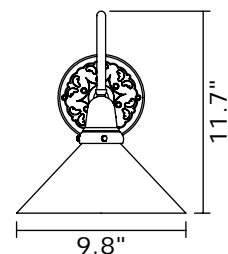
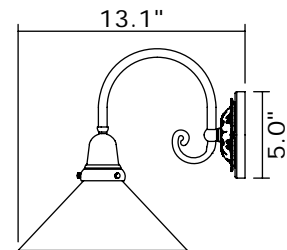

PROVENCE™ ONE LIGHT SEMI FLUSH CEILING FIXTURE

WITH 2-1/4" SHADE HOLDER

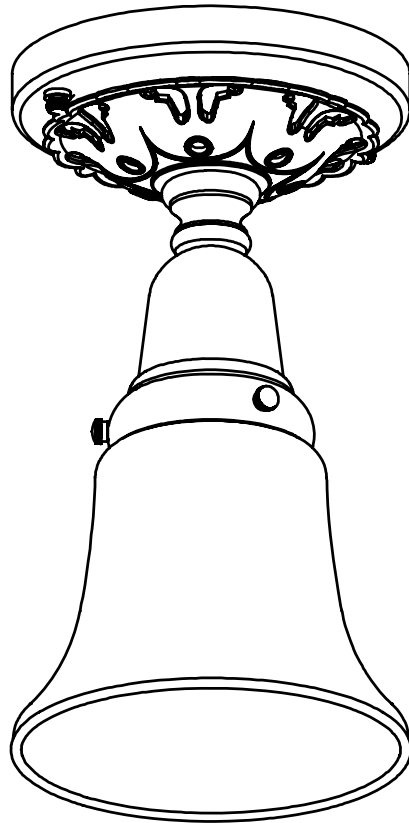

**NEW
CLASSICS™**
Handmade in USA

FINISHES - applied by hand.

Polished Nickel	Architectural Bronze
Brushed Nickel	Verdigris Patina
Black	Distressed Brass
Brushed Brass	Antique Copper
Polished Brass	Satin Antique Brass
Antique Nickel	Unlacquered Pol. Brass
Vintage Nickel	Architectural Iron

CN-401-A4-01M Shown with A151 shade(s)

Medium base screw-in socket (1) accepts 150 W max incandescent, compact fluorescent, or LED.

GU24 base bi-pin socket available. 277V 4 pin socket alternative, inquire.

Check our website for alternative 2-1/4" shades.

Mounting plate center mounts to junction box.

Angled ceiling version available, inquire.

UL listed dry location. Damp location available, inquire.

Durably constructed of solid brass.

Made in USA by Brass Light Gallery.

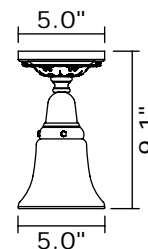

PROVENCE™ ONE LIGHT SEMI FLUSH CEILING FIXTURE

WITH 3-1/4" SHADE HOLDER

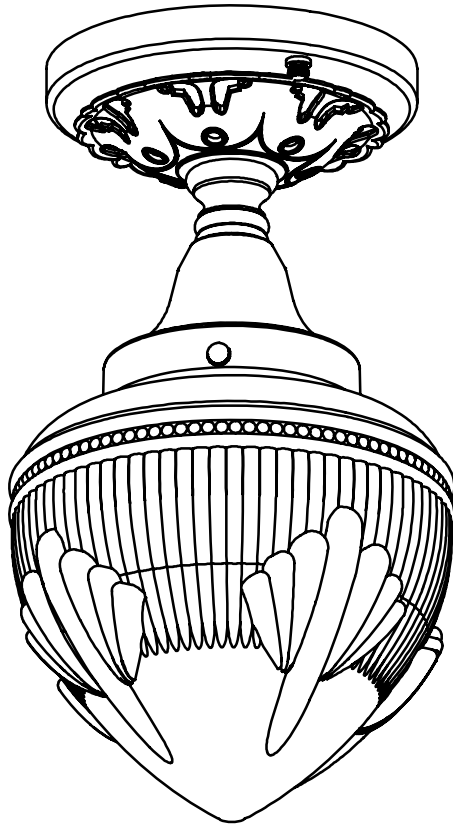

**NEW
CLASSICS™**
Handmade in USA

FINISHES - applied by hand.

Polished Nickel	Architectural Bronze
Brushed Nickel	Verdigris Patina
Black	Distressed Brass
Brushed Brass	Antique Copper
Polished Brass	Satin Antique Brass
Antique Nickel	Unlacquered Pol. Brass
Vintage Nickel	Architectural Iron

CN-401-A5-01M Shown with B100 shade(s)

Medium base screw-in socket (1) accepts 150 W max incandescent, compact fluorescent, or LED.

GU24 base bi-pin socket available. 277V 4 pin socket alternative, inquire.

Check our website for alternative 3-1/4" shades.

Mounting plate center mounts to junction box.

Angled ceiling version available, inquire.

UL listed dry location. Damp location available, inquire.

Durably constructed of solid brass.

Made in USA by Brass Light Gallery.

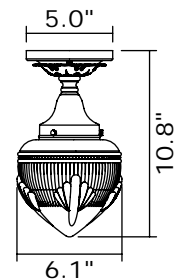

PROVENCE™ ONE LIGHT PENDANT

WITH 2-1/4" SHADE HOLDER

brasslightgallery.com 800-243-9595 sales@brasslight.com

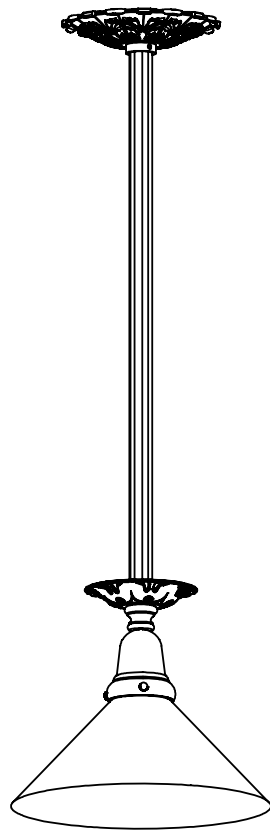

**NEW
CLASSICS™**
Handmade in USA

FINISHES - applied by hand.

Polished Nickel	Architectural Bronze
Brushed Nickel	Verdigris Patina
Black	Distressed Brass
Brushed Brass	Antique Copper
Polished Brass	Satin Antique Brass
Antique Nickel	Unlacquered Pol. Brass
Vintage Nickel	Architectural Iron

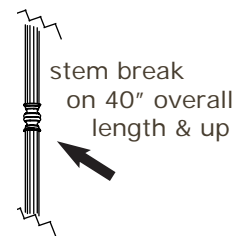

CN-412-A4-03M Shown with A156 shade(s)

Medium base screw-in socket (1) accepts 150 W max incandescent, compact fluorescent, or LED.

GU24 base bi-pin socket available. 277V 4 pin socket alternative, inquire.

Check our website for alternative 2-1/4" shades.

Mounting plate center mounts to junction box.

Specify overall length. Minimum overall length 13".

Angled ceiling version available, inquire.

UL listed dry location. Damp location available, inquire.

Durably constructed of solid brass.

Made in USA by Brass Light Gallery.

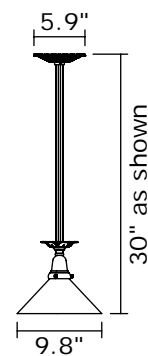

Provence Family v1.0 page 13

PROVENCE™ ONE LIGHT PENDANT

WITH 3-1/4" SHADE HOLDER

brasslightgallery.com 800-243-9595 sales@brasslight.com

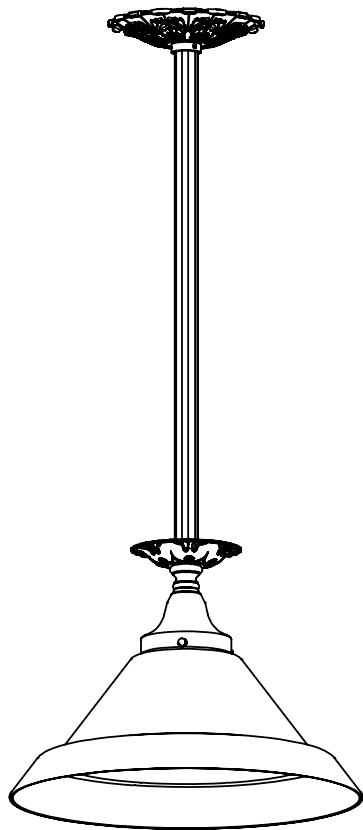

**NEW
CLASSICS™**
Handmade in USA

FINISHES - applied by hand.

Polished Nickel	Architectural Bronze
Brushed Nickel	Verdigris Patina
Black	Distressed Brass
Brushed Brass	Antique Copper
Polished Brass	Satin Antique Brass
Antique Nickel	Unlacquered Pol. Brass
Vintage Nickel	Architectural Iron

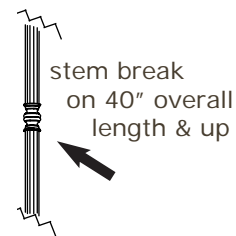

CN-412-A5-03M Shown with B345 shade(s)

Medium base screw-in socket (1) accepts 150 W max incandescent, compact fluorescent, or LED.

GU24 base bi-pin socket available. 277V 4 pin socket alternative, inquire.

Check our website for alternative 3-1/4" shades.

Mounting plate center mounts to junction box.

Specify overall length. Minimum overall length 13".

Angled ceiling version available, inquire.

UL listed dry location. Damp location available, inquire.

Durably constructed of solid brass.

Made in USA by Brass Light Gallery.

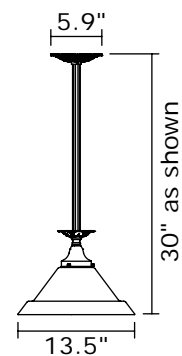

Provence Family v1.0 page 14

PROVENCE™ FOUR LIGHT PETITE CHANDELIER

WITH ELECTRIC CANDLES AND CRYSTAL

brasslightgallery.com 800-243-9595 sales@brasslight.com

Provence Family v1.0 page 15

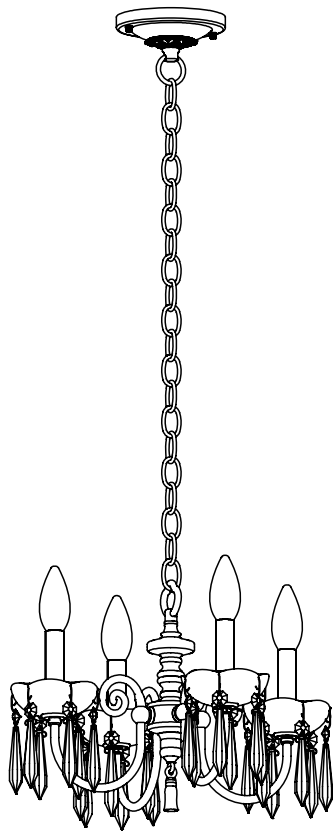

**NEW
CLASSICS™**
Handmade in USA

FINISHES - applied by hand.

Polished Nickel	Architectural Bronze
Brushed Nickel	Verdigris Patina
Black	Distressed Brass
Brushed Brass	Antique Copper
Polished Brass	Satin Antique Brass
Antique Nickel	Unlacquered Pol. Brass
Vintage Nickel	Architectural Iron

CN-438-B2-05M Shown without shade(s)

Candelabra base screw-in sockets (4) each accept 60 W max incandescent, compact fluorescent, or LED.

Check online for alternative clip-on shades rated at 40 to 60 watts with this fixture.

Mounting plate center mounts to junction box.

Specify overall length. Minimum overall length 15".

Mount to flat or to angled ceiling.

UL listed dry location.

Durably constructed of solid brass.

Made in USA by Brass Light Gallery.

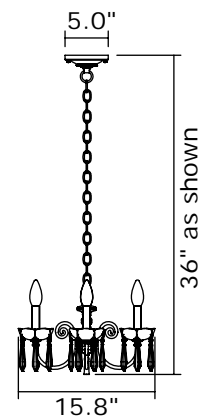

BRASS LIGHT GALLERY
• MILWAUKEE •

© 2012, Brass Light Gallery®

PROVENCE™ FOUR LIGHT PETITE CHANDELIER

WITH ELECTRIC CANDLES

brasslightgallery.com 800-243-9595 sales@brasslight.com

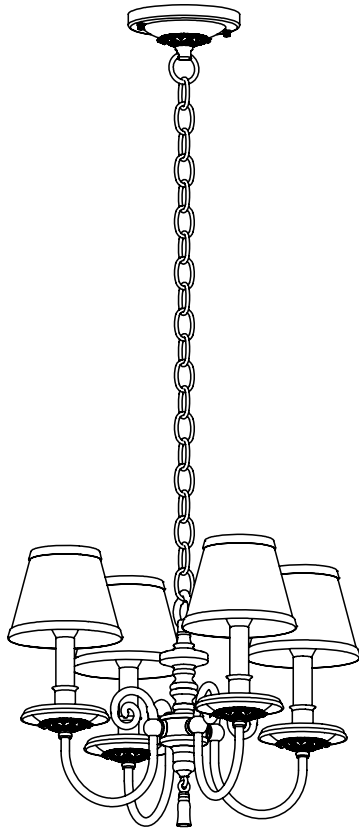

**NEW
CLASSICS™**
Handmade in USA

FINISHES - applied by hand.

Polished Nickel	Architectural Bronze
Brushed Nickel	Verdigris Patina
Black	Distressed Brass
Brushed Brass	Antique Copper
Polished Brass	Satin Antique Brass
Antique Nickel	Unlacquered Pol. Brass
Vintage Nickel	Architectural Iron

CN-438-E4-05M Shown with E220 shade(s)

Candelabra base screw-in sockets (4) each accept 60 W max incandescent, compact fluorescent, or LED.

Check online for alternative clip-on shades rated at 40 to 60 watts with this fixture.

Mounting plate center mounts to junction box.

Specify overall length. Minimum overall length 15".

Mount to flat or to angled ceiling.

UL listed dry location.

Durably constructed of solid brass.

Made in USA by Brass Light Gallery.

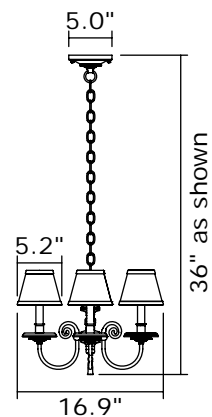

Provence Family v1.0 page 16

BRASS LIGHT GALLERY
• MILWAUKEE •

© 2012, Brass Light Gallery®

PROVENCE™ TWO LIGHT CHANDELIER

WITH 2-1/4" SHADE HOLDERS DOWN

brasslightgallery.com 800-243-9595 sales@brasslight.com

Provence Family v1.0 page 17

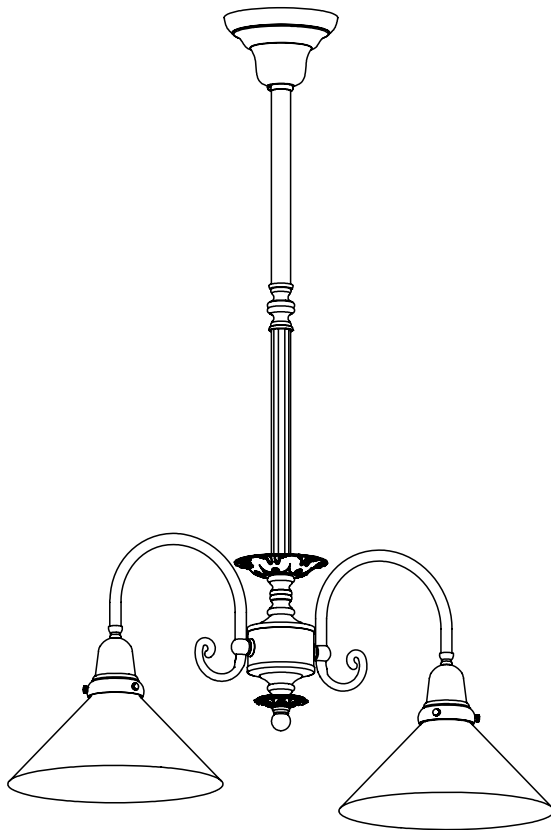

NEW CLASSICS™
Handmade in USA

FINISHES - applied by hand.

Polished Nickel	Architectural Bronze
Brushed Nickel	Verdigris Patina
Black	Distressed Brass
Brushed Brass	Antique Copper
Polished Brass	Satin Antique Brass
Antique Nickel	Unlacquered Pol. Brass
Vintage Nickel	Architectural Iron

CN-460-A4-03M Shown with A156 shade(s)

Medium base screw-in sockets (2) each accept 150 W max incandescent, compact fluorescent, or LED.

GU24 base bi-pin socket available. 277V 4 pin socket alternative, inquire.

Check our website for alternative 2-1/4" shades.

Mounting plate center mounts to junction box.

Specify overall length. Minimum overall length 18".

Angled ceiling version available, inquire.

UL listed dry location.

Durably constructed of solid brass.

Made in USA by Brass Light Gallery.

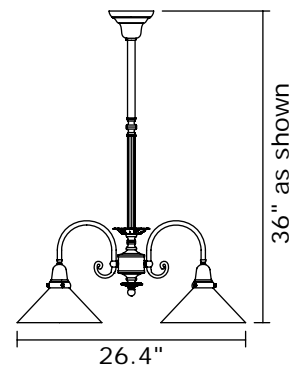
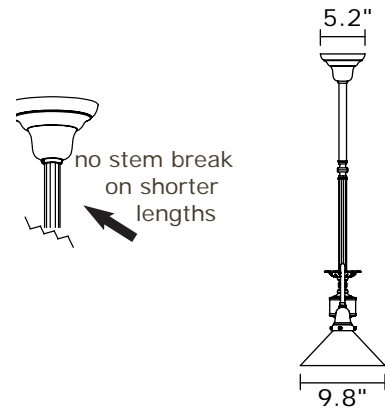

BRASS LIGHT GALLERY
• MILWAUKEE •

© 2012, Brass Light Gallery®

PROVENCE™ TWO LIGHT CHANDELIER

WITH 2-1/4" SHADE HOLDERS UP

brasslightgallery.com 800-243-9595 sales@brasslight.com

Provence Family v1.0 page 18

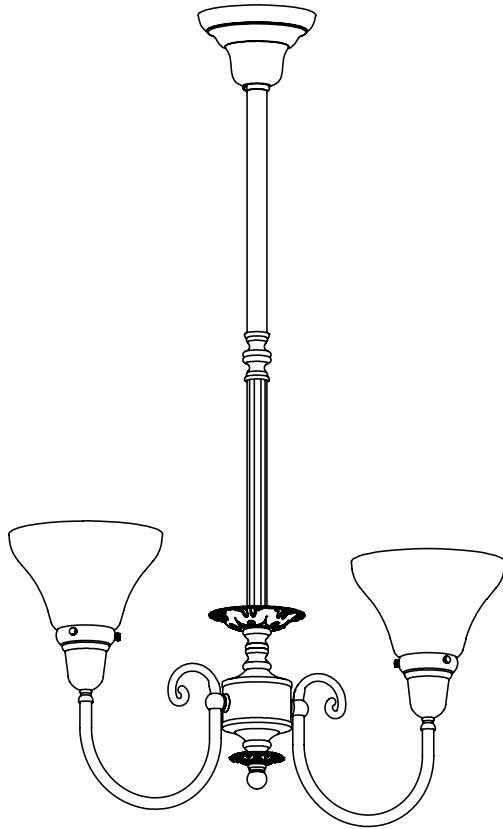

NEW CLASSICS™
Handmade in USA

FINISHES - applied by hand.

Polished Nickel	Architectural Bronze
Brushed Nickel	Verdigris Patina
Black	Distressed Brass
Brushed Brass	Antique Copper
Polished Brass	Satin Antique Brass
Antique Nickel	Unlacquered Pol. Brass
Vintage Nickel	Architectural Iron

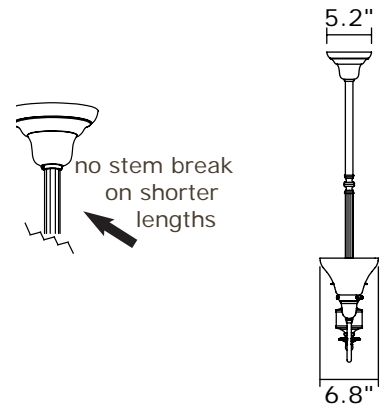

CN-460-A4-09M Shown with A154 shade(s)

Medium base screw-in sockets (2) each accept 150 W max incandescent, compact fluorescent, or LED.

GU24 base bi-pin socket available. 277V 4 pin socket alternative, inquire.

Check our website for alternative 2-1/4" shades.

Mounting plate center mounts to junction box.

Specify overall length. Minimum overall length 16".

Angled ceiling version available, inquire.

UL listed dry location.

Durably constructed of solid brass.

Made in USA by Brass Light Gallery.

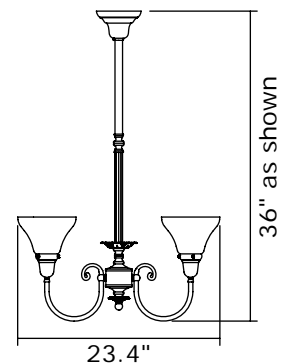

BRASS LIGHT GALLERY
• MILWAUKEE •

© 2012, Brass Light Gallery®

PROVENCE™ TWO LIGHT CHANDELIER

WITH ELECTRIC CANDLES

brasslightgallery.com 800-243-9595 sales@brasslight.com

Provence Family v1.0 page 19

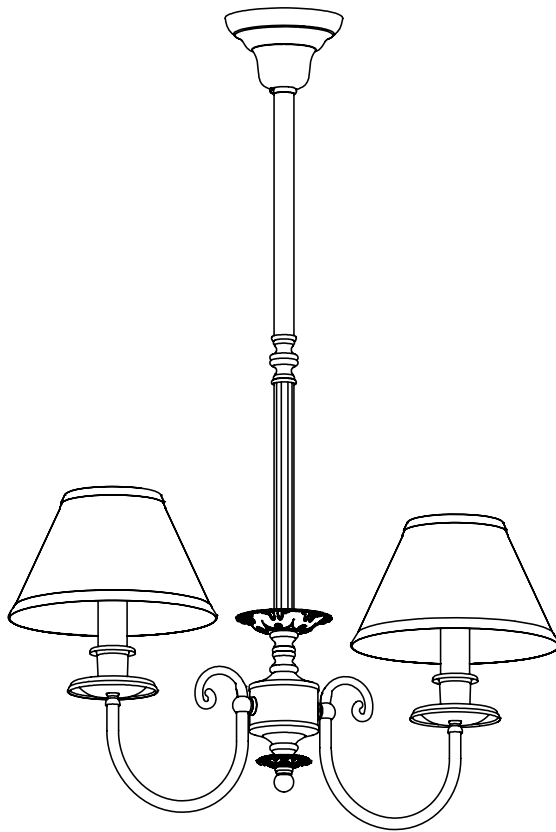

**NEW
CLASSICS™**
Handmade in USA

FINISHES - applied by hand.

Polished Nickel	Architectural Bronze
Brushed Nickel	Verdigris Patina
Black	Distressed Brass
Brushed Brass	Antique Copper
Polished Brass	Satin Antique Brass
Antique Nickel	Unlacquered Pol. Brass
Vintage Nickel	Architectural Iron

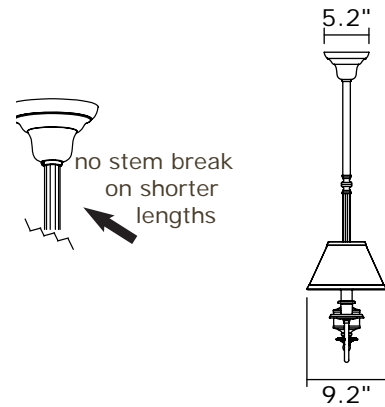

CN-460-B7-09M Shown with F248 shade(s)

Medium base screw-in sockets (2) each accept 60 W max incandescent, compact fluorescent, or LED.

GU24 base bi-pin socket available. 277V 4 pin socket alternative, inquire.

Check online for alternative clip-on shades rated at 40 to 100 watts with this fixture.

Mounting plate center mounts to junction box.

Specify overall length. Minimum overall length 17".

Angled ceiling version available, inquire.

UL listed dry location.

Durably constructed of solid brass.

Made in USA by Brass Light Gallery.

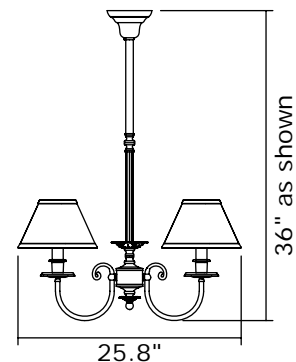

BRASS LIGHT GALLERY
• MILWAUKEE •

© 2012, Brass Light Gallery®

PROVENCE™ THREE LIGHT CHANDELIER

WITH 2-1/4" SHADE HOLDERS DOWN

brasslightgallery.com 800-243-9595 sales@brasslight.com

Provence Family v1.0 page 20

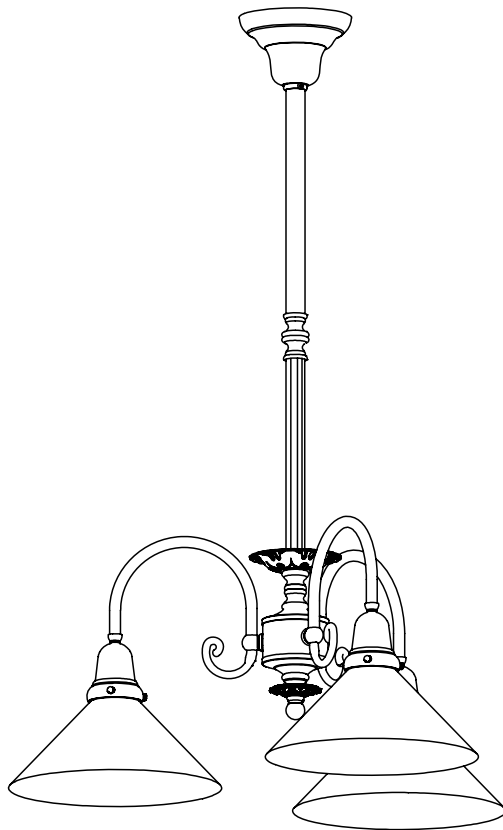

**NEW
CLASSICS™**
Handmade in USA

FINISHES - applied by hand.

Polished Nickel	Architectural Bronze
Brushed Nickel	Verdigris Patina
Black	Distressed Brass
Brushed Brass	Antique Copper
Polished Brass	Satin Antique Brass
Antique Nickel	Unlacquered Pol. Brass
Vintage Nickel	Architectural Iron

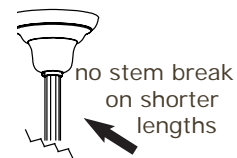

CN-462-A4-03M Shown with A156 shade(s)

Medium base screw-in sockets (3) each accept 150 W max incandescent, compact fluorescent, or LED.

GU24 base bi-pin socket available. 277V 4 pin socket alternative, inquire.

Check our website for alternative 2-1/4" shades.

Mounting plate center mounts to junction box.

Specify overall length. Minimum overall length 18".

Angled ceiling version available, inquire.

UL listed dry location.

Durably constructed of solid brass.

Made in USA by Brass Light Gallery.

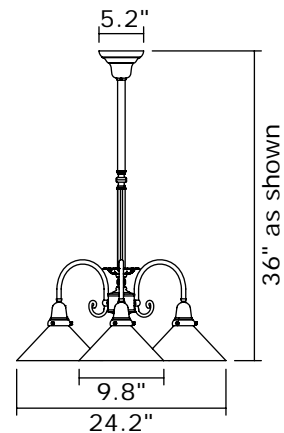

BRASS LIGHT GALLERY
• MILWAUKEE •

© 2012, Brass Light Gallery®

PROVENCE™ THREE LIGHT CHANDELIER

WITH 2-1/4" SHADE HOLDERS UP

brasslightgallery.com 800-243-9595 sales@brasslight.com

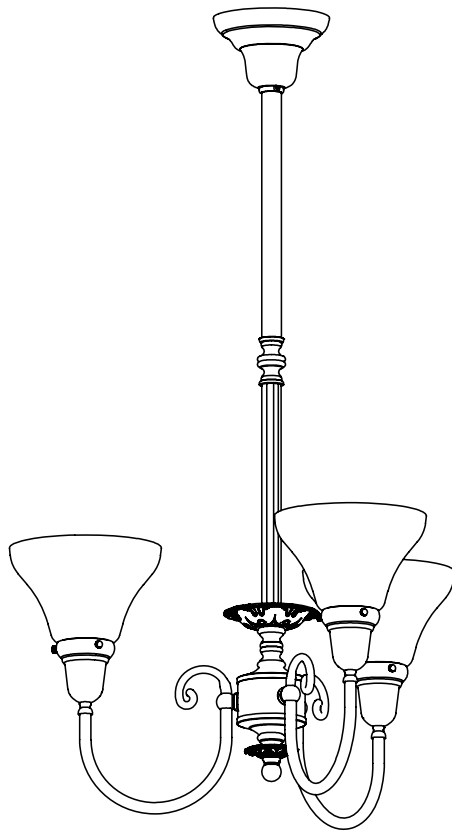

**NEW
CLASSICS™**
Handmade in USA

FINISHES - applied by hand.

Polished Nickel	Architectural Bronze
Brushed Nickel	Verdigris Patina
Black	Distressed Brass
Brushed Brass	Antique Copper
Polished Brass	Satin Antique Brass
Antique Nickel	Unlacquered Pol. Brass
Vintage Nickel	Architectural Iron

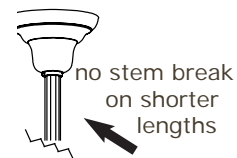

CN-462-A4-09M Shown with A154 shade(s)

Medium base screw-in sockets (3) each accept 150 W max incandescent, compact fluorescent, or LED.

GU24 base bi-pin socket available. 277V 4 pin socket alternative, inquire.

Check our website for alternative 2-1/4" shades.

Mounting plate center mounts to junction box.

Specify overall length. Minimum overall length 16".

Angled ceiling version available, inquire.

UL listed dry location.

Durably constructed of solid brass.

Made in USA by Brass Light Gallery.

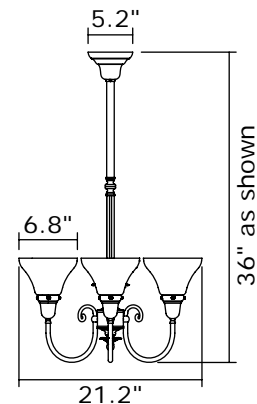

Provence Family v1.0 page 21

BRASS LIGHT GALLERY
• MILWAUKEE •

© 2012, Brass Light Gallery®

PROVENCE™ THREE LIGHT CHANDELIER

WITH ELECTRIC CANDLE

brasslightgallery.com 800-243-9595 sales@brasslight.com

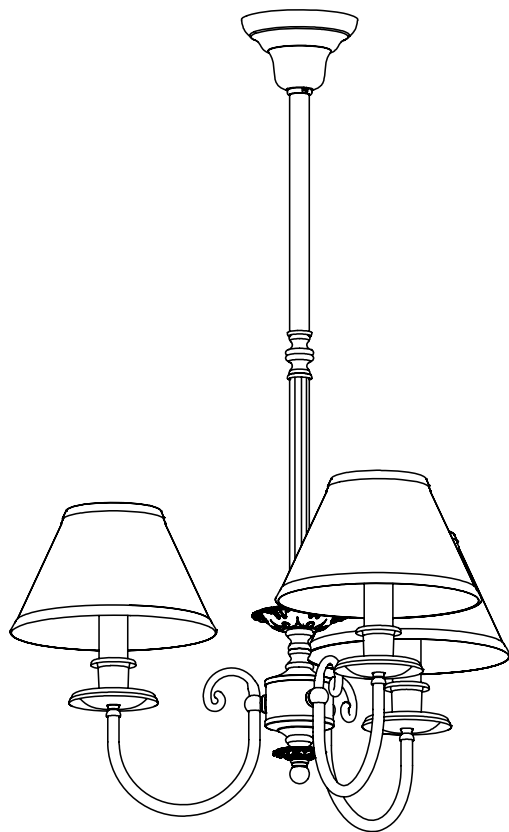

NEW
CLASSICS™
Handmade in USA

FINISHES - applied by hand.

Polished Nickel	Architectural Bronze
Brushed Nickel	Verdigris Patina
Black	Distressed Brass
Brushed Brass	Antique Copper
Polished Brass	Satin Antique Brass
Antique Nickel	Unlacquered Pol. Brass
Vintage Nickel	Architectural Iron

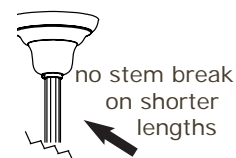

CN-462-B7-09M Shown with F248 shade(s)

Medium base screw-in sockets (3) each accept 100 W max incandescent, compact fluorescent, or LED.

GU24 base bi-pin socket available. 277V 4 pin socket alternative, inquire.

Check online for alternative clip-on shades rated at 40 to 100 watts with this fixture.

Mounting plate center mounts to junction box.

Specify overall length. Minimum overall length 17".

Angled ceiling version available, inquire.

UL listed dry location.

Durably constructed of solid brass.

Made in USA by Brass Light Gallery.

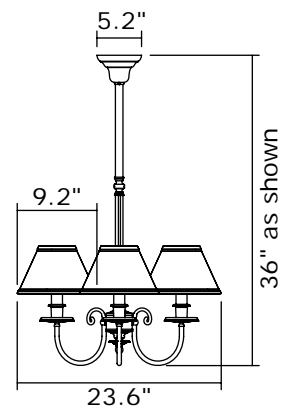

Provence Family v1.0 page 22

PROVENCE™ FOUR LIGHT CHANDELIER

WITH 2-1/4" SHADE HOLDERS DOWN

brasslightgallery.com 800-243-9595 sales@brasslight.com

Provence Family v1.0 page 23

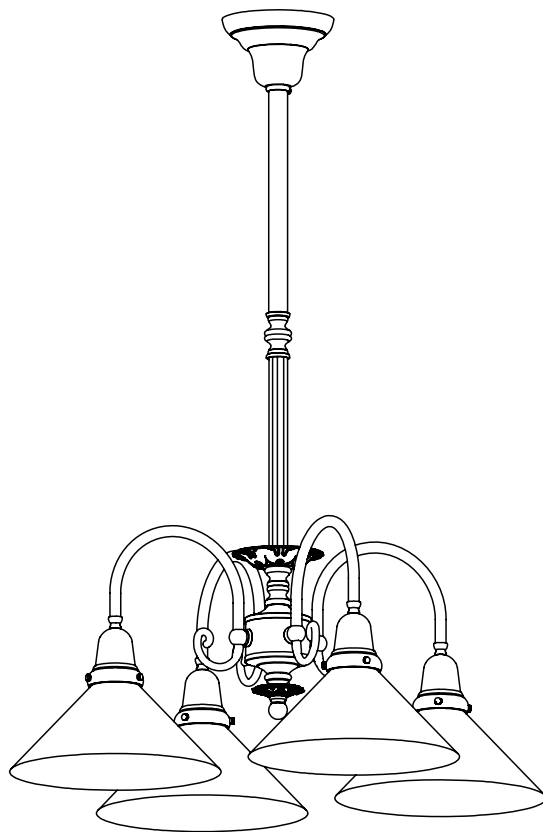

NEW
CLASSICS™
Handmade in USA

FINISHES - applied by hand.

Polished Nickel	Architectural Bronze
Brushed Nickel	Verdigris Patina
Black	Distressed Brass
Brushed Brass	Antique Copper
Polished Brass	Satin Antique Brass
Antique Nickel	Unlacquered Pol. Brass
Vintage Nickel	Architectural Iron

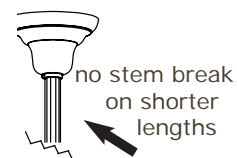

CN-464-A4-03M Shown with A156 shade(s)

Medium base screw-in sockets (4) each accept 150 W max incandescent, compact fluorescent, or LED.

GU24 base bi-pin socket available. 277V 4 pin socket alternative, inquire.

Check our website for alternative 2-1/4" shades.

Mounting plate center mounts to junction box.

Specify overall length. Minimum overall length 18".

Angled ceiling version available, inquire.

UL listed dry location.

Durably constructed of solid brass.

Made in USA by Brass Light Gallery.

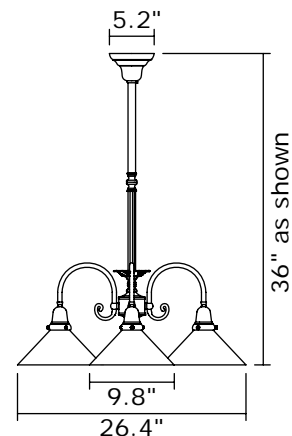

BRASS LIGHT GALLERY
• MILWAUKEE •

© 2012, Brass Light Gallery®

PROVENCE™ FOUR LIGHT CHANDELIER

WITH 2-1/4" SHADE HOLDERS UP

brasslightgallery.com 800-243-9595 sales@brasslight.com

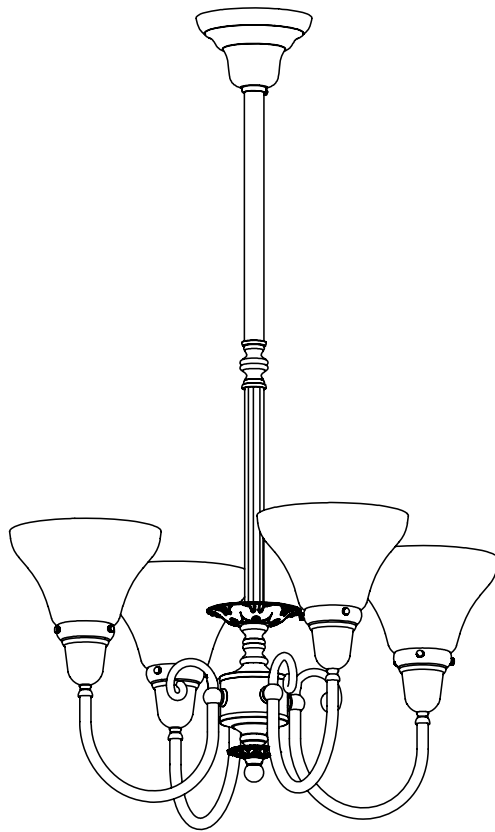

**NEW
CLASSICS™**
Handmade in USA

FINISHES - applied by hand.

Polished Nickel	Architectural Bronze
Brushed Nickel	Verdigris Patina
Black	Distressed Brass
Brushed Brass	Antique Copper
Polished Brass	Satin Antique Brass
Antique Nickel	Unlacquered Pol. Brass
Vintage Nickel	Architectural Iron

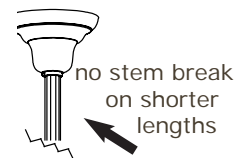

CN-464-A4-09M Shown with A154 shade(s)

Medium base screw-in sockets (4) each accept 150 W max incandescent, compact fluorescent, or LED.

GU24 base bi-pin socket available. 277V 4 pin socket alternative, inquire.

Check our website for alternative 2-1/4" shades.

Mounting plate center mounts to junction box.

Specify overall length. Minimum overall length 16".

Angled ceiling version available, inquire.

UL listed dry location.

Durably constructed of solid brass.

Made in USA by Brass Light Gallery.

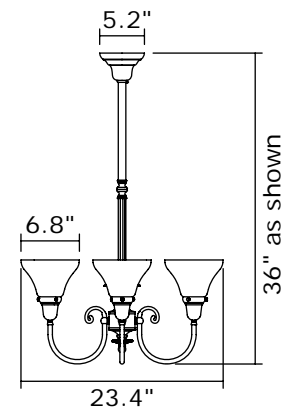

Provence Family v1.0 page 24

BRASS LIGHT GALLERY
• MILWAUKEE •

© 2012, Brass Light Gallery®

PROVENCE™ FOUR LIGHT CHANDELIER

WITH ELECTRIC CANDLES

brasslightgallery.com 800-243-9595 sales@brasslight.com

Provence Family v1.0 page 25

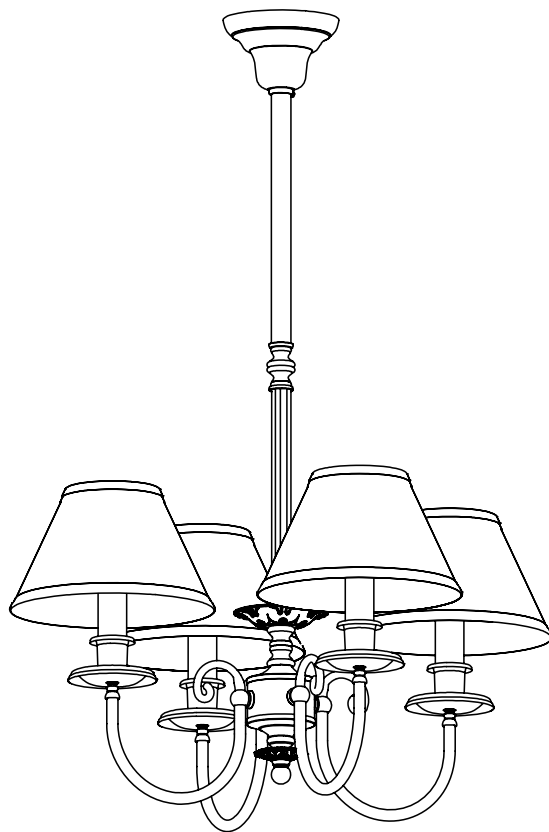

NEW CLASSICS™
Handmade in USA

FINISHES - applied by hand.

Polished Nickel	Architectural Bronze
Brushed Nickel	Verdigris Patina
Black	Distressed Brass
Brushed Brass	Antique Copper
Polished Brass	Satin Antique Brass
Antique Nickel	Unlacquered Pol. Brass
Vintage Nickel	Architectural Iron

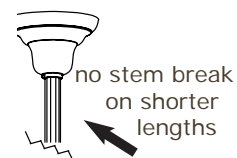

CN-464-B7-09M Shown with F248 shade(s)

Medium base screw-in sockets (4) each accept 100 W max incandescent, compact fluorescent, or LED.

GU24 base bi-pin socket available. 277V 4 pin socket alternative, inquire.

Check online for alternative clip-on shades rated at 40 to 100 watts with this fixture.

Mounting plate center mounts to junction box.

Specify overall length. Minimum overall length 17".

Angled ceiling version available, inquire.

UL listed dry location.

Durably constructed of solid brass.

Made in USA by Brass Light Gallery.

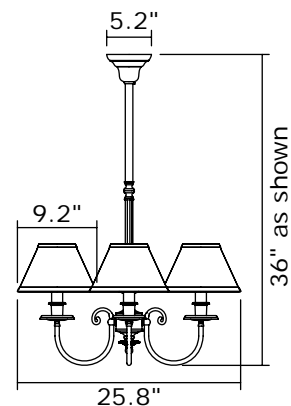

BRASS LIGHT GALLERY
• MILWAUKEE •

© 2012, Brass Light Gallery®

PROVENCE™ SIX LIGHT CHANDELIER

WITH 2-1/4" SHADE HOLDERS UP

brasslightgallery.com 800-243-9595 sales@brasslight.com

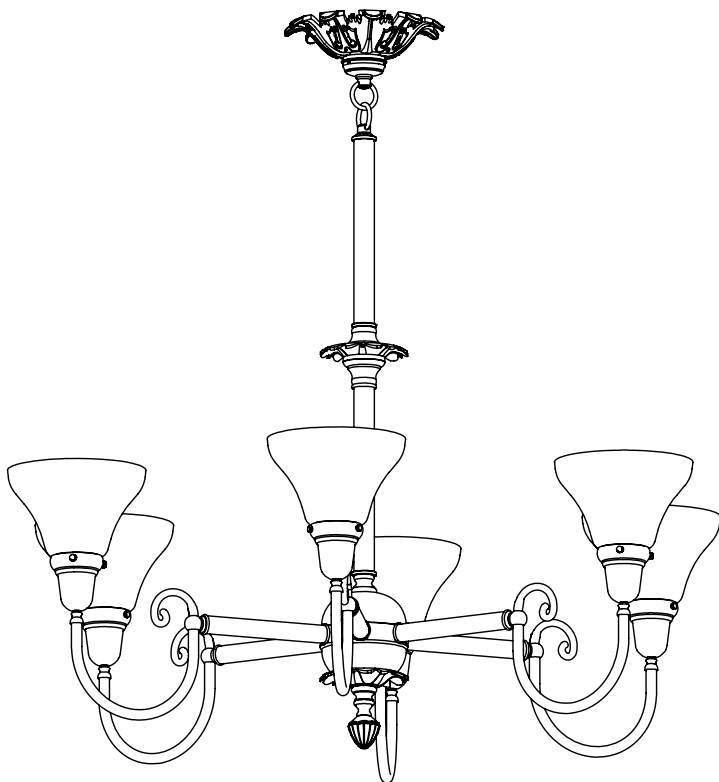

**NEW
CLASSICS™**
Handmade in USA

FINISHES - applied by hand.

Polished Nickel	Architectural Bronze
Brushed Nickel	Verdigris Patina
Black	Distressed Brass
Brushed Brass	Antique Copper
Polished Brass	Satin Antique Brass
Antique Nickel	Unlacquered Pol. Brass
Vintage Nickel	Architectural Iron

CN-490-A4-10M Shown with A154 shade(s)

Medium base screw-in sockets (6) each accept 150 W max incandescent, compact fluorescent, or LED.

GU24 base bi-pin socket available. 277V 4 pin socket alternative, inquire.

Check our website for alternative 2-1/4" shades.

Mounting plate center mounts to junction box.

Specify overall length. Minimum overall length 20".

Mount to flat or to angled ceiling.

UL listed dry location.

Durably constructed of solid brass.

Made in USA by Brass Light Gallery.

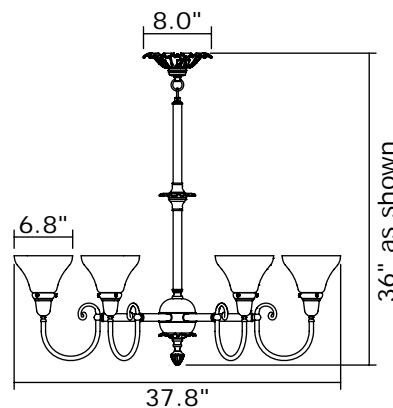

Provence Family v1.0 page 26

PROVENCE™ SIX LIGHT CHANDELIER

WITH 3-1/4" SHADE HOLDERS UP

brasslightgallery.com 800-243-9595 sales@brasslight.com

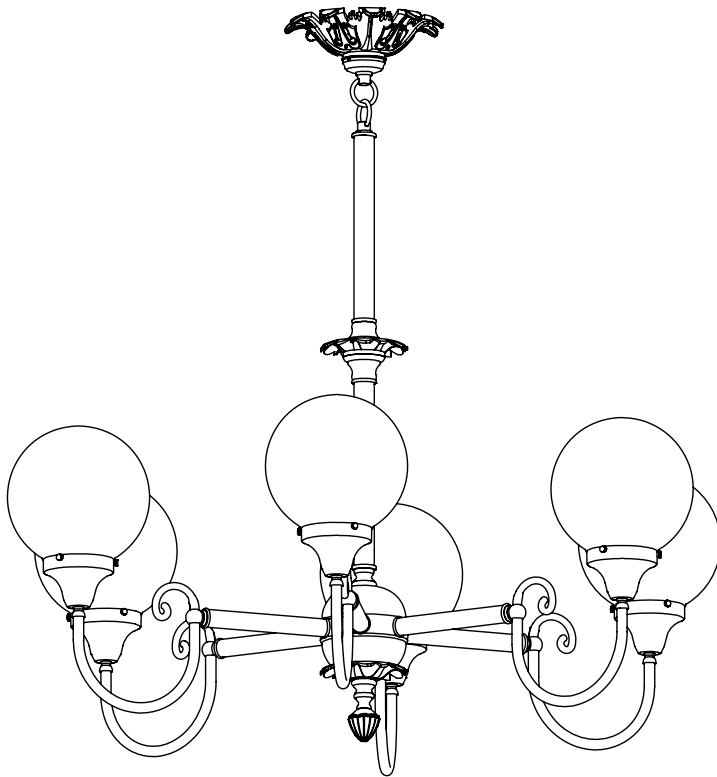

**NEW
CLASSICS™**
Handmade in USA

FINISHES - applied by hand.

Polished Nickel	Architectural Bronze
Brushed Nickel	Verdigris Patina
Black	Distressed Brass
Brushed Brass	Antique Copper
Polished Brass	Satin Antique Brass
Antique Nickel	Unlacquered Pol. Brass
Vintage Nickel	Architectural Iron

CN-490-A5-10M Shown with B312 shade(s)

Medium base screw-in sockets (6) each accept 150 W max incandescent, compact fluorescent, or LED.

GU24 base bi-pin socket available. 277V 4 pin socket alternative, inquire.

Check our website for alternative 3-1/4" shades.

Mounting plate center mounts to junction box.

Specify overall length. Minimum overall length 20".

Mount to flat or to angled ceiling.

UL listed dry location.

Durably constructed of solid brass.

Made in USA by Brass Light Gallery.

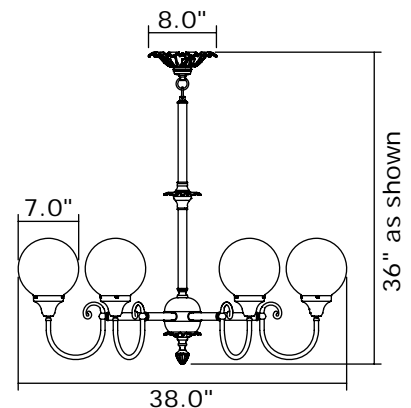

Provence Family v1.0 page 27

BRASS LIGHT GALLERY
• MILWAUKEE •

© 2012, Brass Light Gallery®

PROVENCE™ SIX LIGHT CHANDELIER

WITH ELECTRIC CANDLES

brasslightgallery.com 800-243-9595 sales@brasslight.com

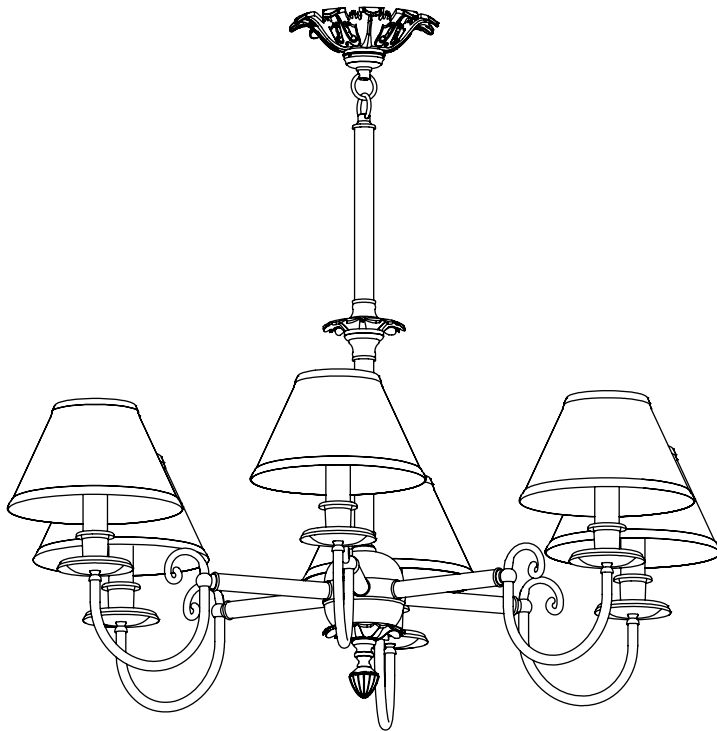

**NEW
CLASSICS™**
Handmade in USA

FINISHES - applied by hand.

Polished Nickel	Architectural Bronze
Brushed Nickel	Verdigris Patina
Black	Distressed Brass
Brushed Brass	Antique Copper
Polished Brass	Satin Antique Brass
Antique Nickel	Unlacquered Pol. Brass
Vintage Nickel	Architectural Iron

CN-490-B7-10M Shown with F248 shade(s)

Medium base screw-in sockets (6) each accept 100 W max incandescent, compact fluorescent, or LED.

GU24 base bi-pin socket available. 277V 4 pin socket alternative, inquire.

Check online for alternative clip-on shades rated at 40 to 100 watts with this fixture.

Mounting plate center mounts to junction box.

Specify overall length. Minimum overall length 17".

Mount to flat or to angled ceiling.

UL listed dry location.

Durably constructed of solid brass.

Made in USA by Brass Light Gallery.

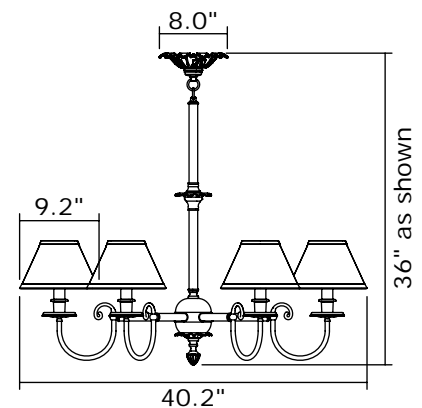

Provence Family v1.0 page 28

BRASS LIGHT GALLERY
• MILWAUKEE •

© 2012, Brass Light Gallery®

PROVENCE™ NINE LIGHT TWO TIER CHANDELIER

WITH 2-1/4" SHADE HOLDERS UP

brasslightgallery.com 800-243-9595 sales@brasslight.com

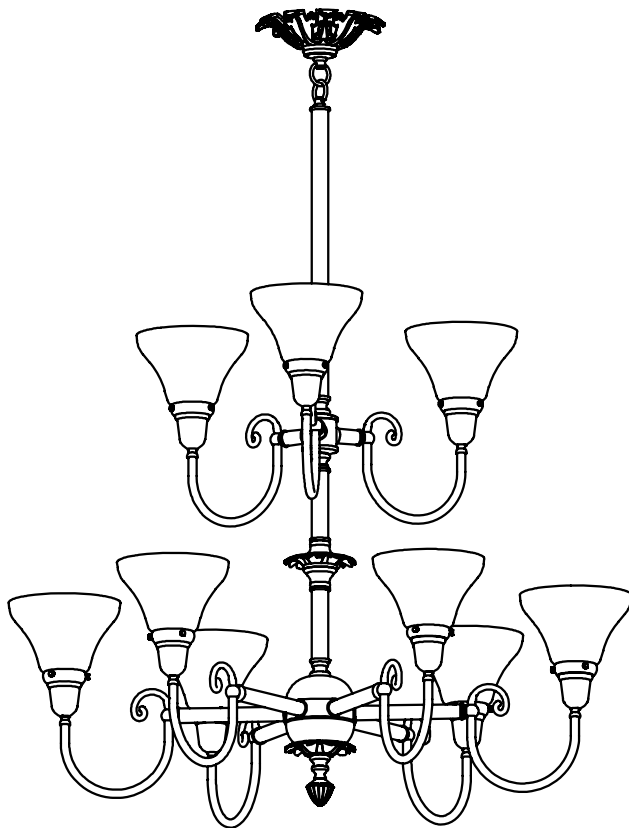

**NEW
CLASSICS™**
Handmade in USA

FINISHES - applied by hand.

Polished Nickel	Architectural Bronze
Brushed Nickel	Verdigris Patina
Black	Distressed Brass
Brushed Brass	Antique Copper
Polished Brass	Satin Antique Brass
Antique Nickel	Unlacquered Pol. Brass
Vintage Nickel	Architectural Iron

CN-491-A4-10M Shown with A154 shade(s)

Medium base screw-in sockets (9) each accept 150 W max incandescent, compact fluorescent, or LED.

GU24 base bi-pin socket available. 277V 4 pin socket alternative, inquire.

Check our website for alternative 2-1/4" shades.

Mounting plate center mounts to junction box.

Specify overall length. Minimum overall length 36".

Mount to flat or to angled ceiling.

UL listed dry location.

Durably constructed of solid brass.

Made in USA by Brass Light Gallery.

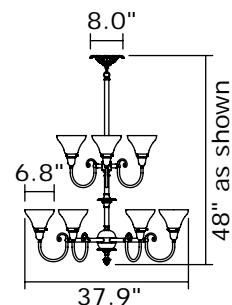

Provence Family v1.0 page 29

BRASS LIGHT GALLERY
• MILWAUKEE •

© 2012, Brass Light Gallery®

PROVENCE™ NINE LIGHT TWO TIER CHANDELIER

WITH 3-1/4" SHADE HOLDERS UP

brasslightgallery.com 800-243-9595 sales@brasslight.com

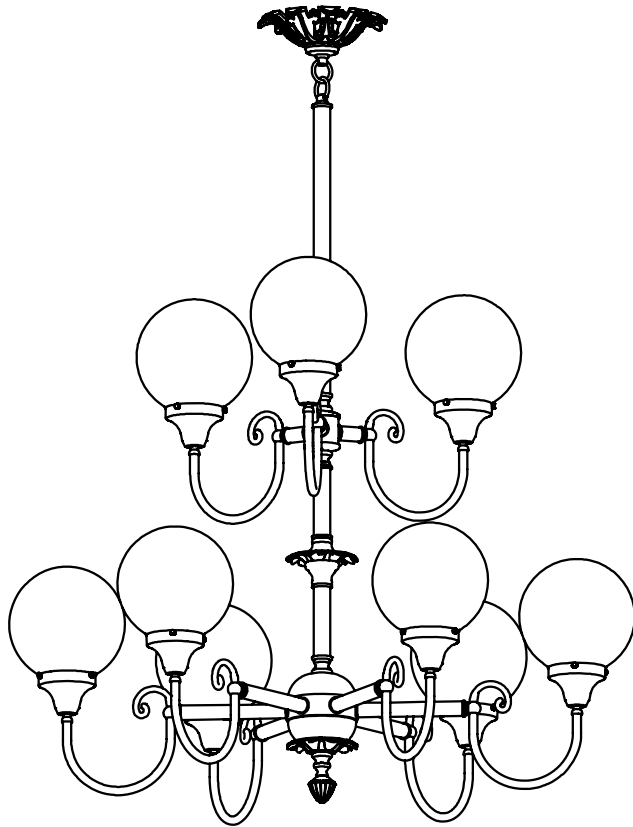

**NEW
CLASSICS™**
Handmade in USA

FINISHES - applied by hand.

Polished Nickel	Architectural Bronze
Brushed Nickel	Verdigris Patina
Black	Distressed Brass
Brushed Brass	Antique Copper
Polished Brass	Satin Antique Brass
Antique Nickel	Unlacquered Pol. Brass
Vintage Nickel	Architectural Iron

CN-491-A5-10M Shown with B312 shade(s)

Medium base screw-in sockets (9) each accept 150 W max incandescent, compact fluorescent, or LED.

GU24 base bi-pin socket available. 277V 4 pin socket alternative, inquire.

Check our website for alternative 3-1/4" shades.

Mounting plate center mounts to junction box.

Specify overall length. Minimum overall length 36".

Mount to flat or to angled ceiling.

UL listed dry location.

Durably constructed of solid brass.

Made in USA by Brass Light Gallery.

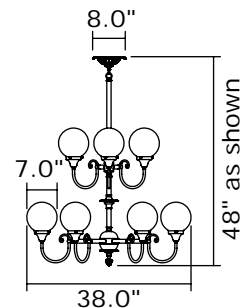

Provence Family v1.0 page 30

BRASS LIGHT GALLERY
• MILWAUKEE •

© 2012, Brass Light Gallery®

PROVENCE™ NINE LIGHT TWO TIER CHANDELIER

WITH ELECTRIC CANDLES

brasslightgallery.com 800-243-9595 sales@brasslight.com

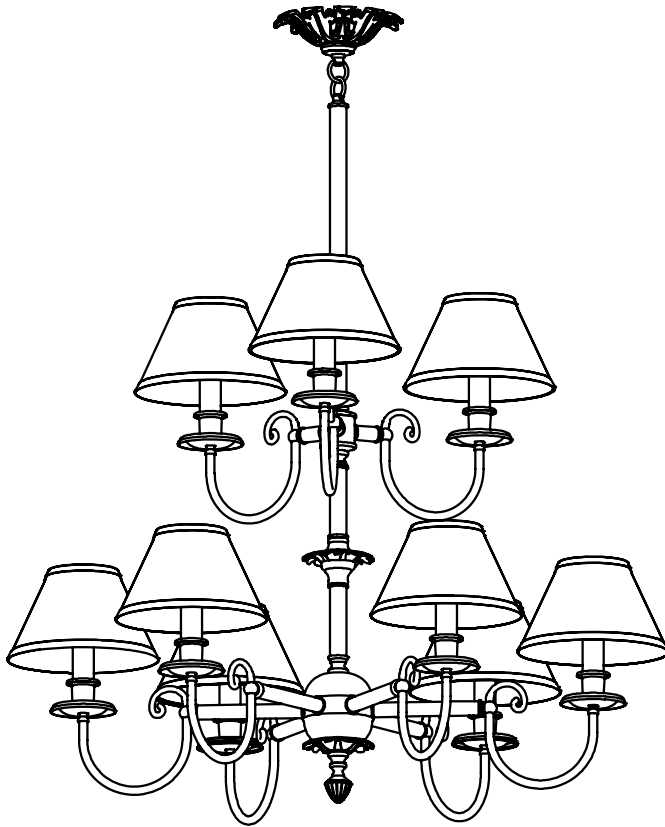

**NEW
CLASSICS™**
Handmade in USA

FINISHES - applied by hand.

Polished Nickel	Architectural Bronze
Brushed Nickel	Verdigris Patina
Black	Distressed Brass
Brushed Brass	Antique Copper
Polished Brass	Satin Antique Brass
Antique Nickel	Unlacquered Pol. Brass
Vintage Nickel	Architectural Iron

CN-491-B7-10M Shown with F248 shade(s)

Medium base screw-in sockets (9) each accept 100 W max incandescent, compact fluorescent, or LED.

GU24 base bi-pin socket available. 277V 4 pin socket alternative, inquire.

Check online for alternative clip-on shades rated at 40 to 100 watts with this fixture.

Mounting plate center mounts to junction box.

Specify overall length. Minimum overall length 36".

Mount to flat or to angled ceiling.

UL listed dry location.

Durably constructed of solid brass.

Made in USA by Brass Light Gallery.

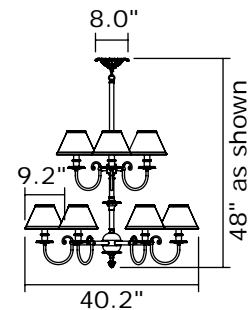

Provence Family v1.0 page 31

BRASS LIGHT GALLERY
• MILWAUKEE •

© 2012, Brass Light Gallery®