

CARLTON™ FAMILY

The Carlton Family, interior light fixtures that are substantial yet understated, perfect for traditional residential or commercial spaces. The Carlton was inspired by a 1905 Milwaukee lakefront mansion lighting fixture.



**NEW
CLASSICS**
Handmade in USA

CARLTON™ FAMILY

INTERIOR LIGHTING FIXTURES

brasslightgallery.com 800-243-9595 sales@brasslight.com

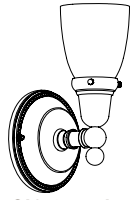

CN-200-A4

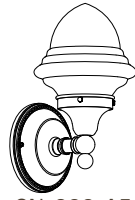

CN-200-A5

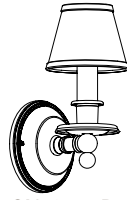

CN-200-B7

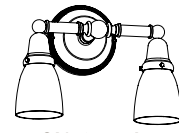

CN-201-A4

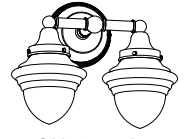

CN-201-A5

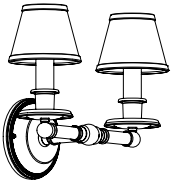

CN-201-B7

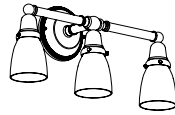

CN-199-A4

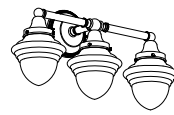

CN-199-A5

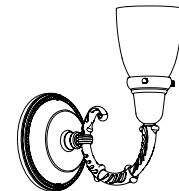

CN-202-A4

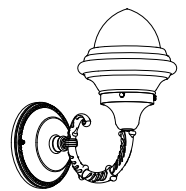

CN-202-A5

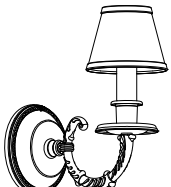

CN-202-B7

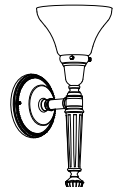

CN-210-A4

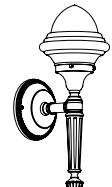

CN-210-A5

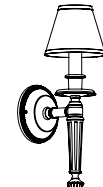

CN-210-B7

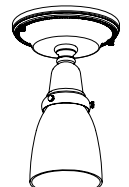

CN-403-A4-01M



CN-403-A5-01M

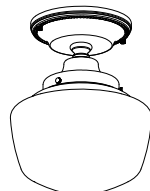

CN-403-A6-01M



CN-403-A8-01M

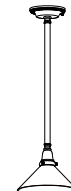

CN-415-A4-03M



CN-415-A5-03M

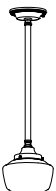

CN-415-A6-03M

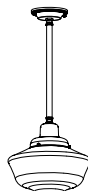

CN-415-A8-03M

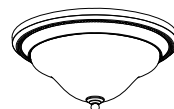

CN-419-01M



CN-433-A4-03M

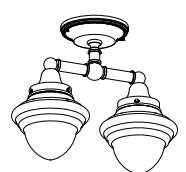

CN-433-A5-03M

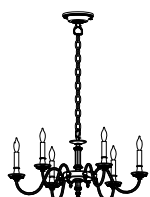

CN-481-E2-05M

Carlton Family v1.0 page 2

CARLTON™ ONE LIGHT STRAIGHT ARM SCONCE

WITH 2-1/4" SHADE HOLDER

brasslightgallery.com 800-243-9595 sales@brasslight.com

Carlton Family v1.0 page 3

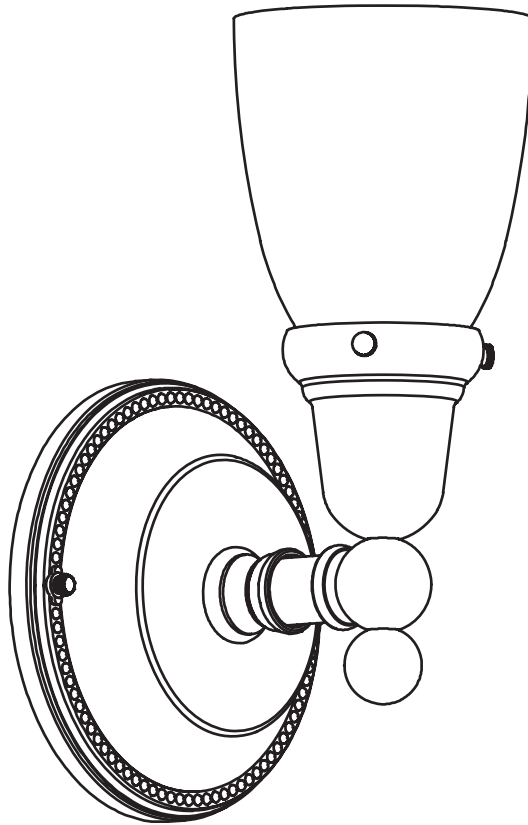

**NEW
CLASSICS**
Handmade in USA

FINISHES - applied by hand.

Polished Nickel	Architectural Bronze
Brushed Nickel	Verdigris Patina
Black	Distressed Brass
Brushed Brass	Antique Copper
Polished Brass	Satin Antique Brass
Antique Nickel	Unlacquered Pol. Brass
Vintage Nickel	Architectural Iron

CN-200-A4 shown with A157 shade

Medium base screw-in socket (1) accepts 150 W max incandescent, compact fluorescent, or LED.

GU24 base bi-pin socket available. 277V 4 pin socket, inquire.

Check our website for alternative 2-1/4" shades.

Center mount to junction box.

Mount glass up or glass down.

UL listed dry location. Damp location available, inquire.

Durably constructed of solid brass.

Made in USA by Brass Light Gallery.

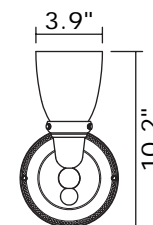
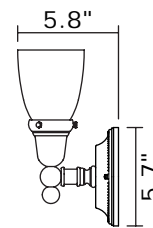

CARLTON™ ONE LIGHT STRAIGHT ARM SCONCE

WITH 3-1/4" SHADE HOLDER

brasslightgallery.com 800-243-9595 sales@brasslight.com

Carlton Family v1.0 page 4

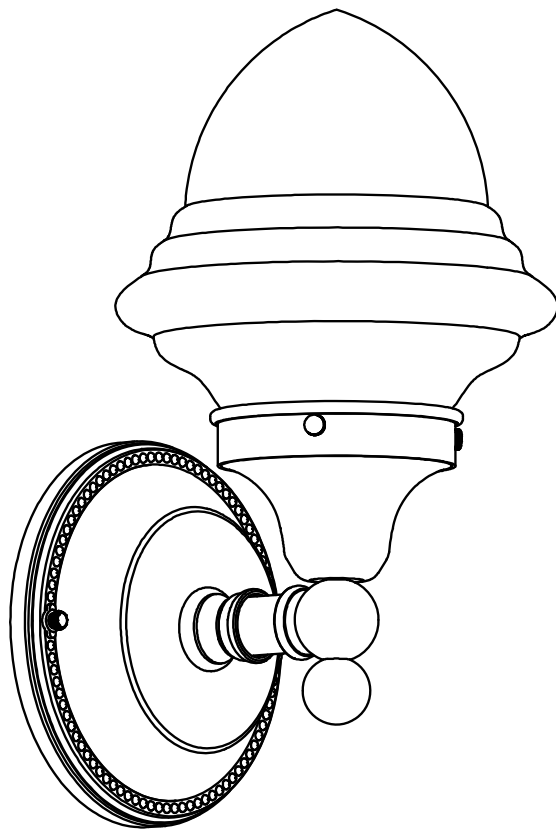

**NEW
CLASSICS**
Handmade in USA

FINISHES - applied by hand.

Polished Nickel	Architectural Bronze
Brushed Nickel	Verdigris Patina
Black	Distressed Brass
Brushed Brass	Antique Copper
Polished Brass	Satin Antique Brass
Antique Nickel	Unlacquered Pol. Brass
Vintage Nickel	Architectural Iron

CN-200-A5 shown with B141 shade

Medium base screw-in socket (1) accepts 150 W max incandescent, compact fluorescent, or LED.

GU24 base bi-pin socket available. 277V 4 pin socket, inquire.

Check our website for alternative 3-1/4" shades.

Center mount to junction box.

Mount glass up or glass down.

UL listed dry location. Damp location available, inquire.

Durably constructed of solid brass.

Made in USA by Brass Light Gallery.

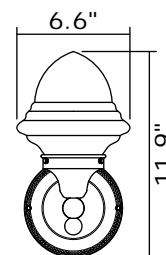
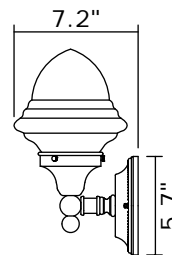

CARLTON™ ONE LIGHT STRAIGHT ARM SCONCE

WITH ELECTRIC CANDLE

brasslightgallery.com 800-243-9595 sales@brasslight.com

Carlton Family v1.0 page 5

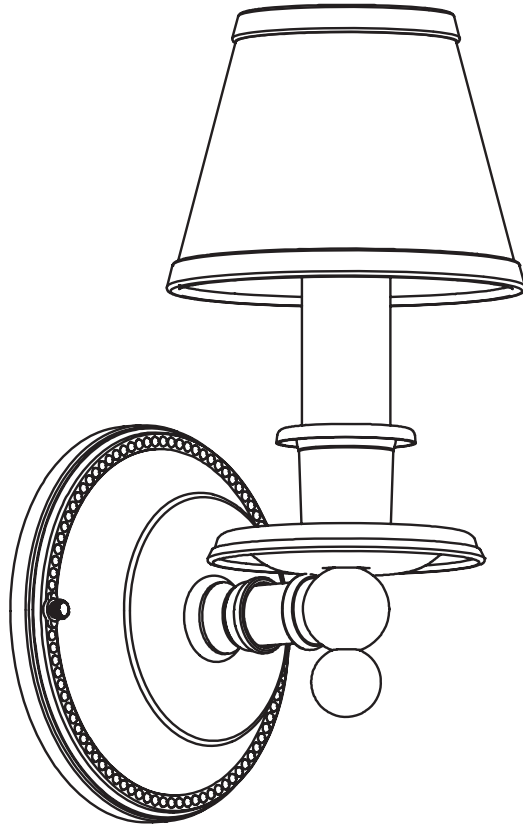

**NEW
CLASSICS**
Handmade in USA

FINISHES - applied by hand.

Polished Nickel	Architectural Bronze
Brushed Nickel	Verdigris Patina
Black	Distressed Brass
Brushed Brass	Antique Copper
Polished Brass	Satin Antique Brass
Antique Nickel	Unlacquered Pol. Brass
Vintage Nickel	Architectural Iron

CN-200-B7 shown with E231 shade

Medium base screw-in socket (1) accepts 60 W max incandescent, compact fluorescent, or LED.

GU24 base bi-pin socket available. 277V 4 pin socket, inquire.

Check our website for alternative clip-on shades.

Center mount to junction box.

Mount candle up.

UL listed dry location.

Durably constructed of solid brass.

Made in USA by Brass Light Gallery.

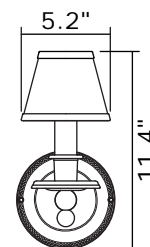
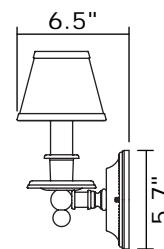

CARLTON™ TWO LIGHT STRAIGHT ARM SCONCE

WITH 2-1/4" SHADE HOLDERS

brasslightgallery.com 800-243-9595 sales@brasslight.com

Carlton Family v1.0 page 6

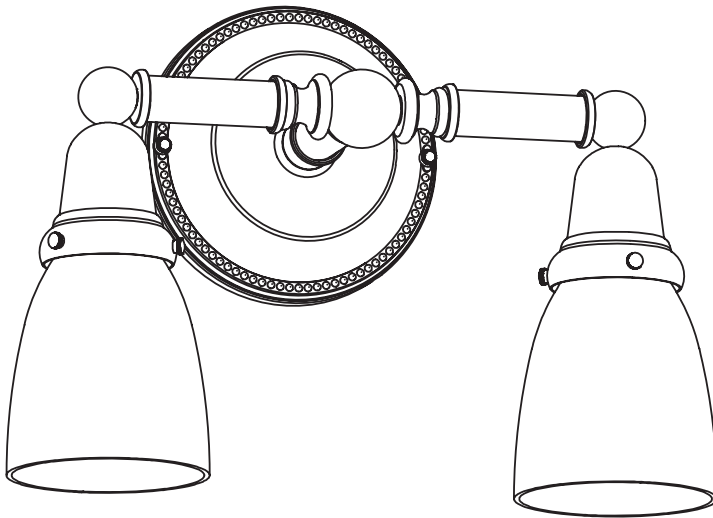

**NEW
CLASSICS**
Handmade in USA

FINISHES - applied by hand.

Polished Nickel	Architectural Bronze
Brushed Nickel	Verdigris Patina
Black	Distressed Brass
Brushed Brass	Antique Copper
Polished Brass	Satin Antique Brass
Antique Nickel	Unlacquered Pol. Brass
Vintage Nickel	Architectural Iron

CN-201-A4 shown with A157 shade

Medium base screw-in sockets (2) each accept 150 W max incandescent, compact fluorescent, or LED.

GU24 base bi-pin socket available. 277V 4 pin socket, inquire.

Check our website for alternative 2-1/4" shades.

Center mount to junction box.

Mount glass up or glass down.

UL listed dry location. Damp location available, inquire.

Durably constructed of solid brass.

Made in USA by Brass Light Gallery.

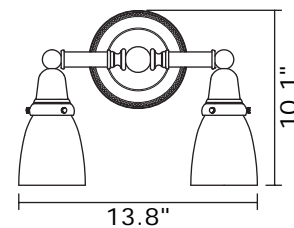
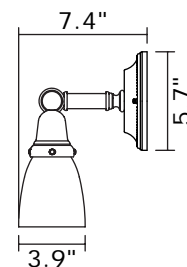

CARLTON™ TWO LIGHT STRAIGHT ARM SCONCE

WITH 3-1/4" SHADE HOLDERS

brasslightgallery.com 800-243-9595 sales@brasslight.com

Carlton Family v1.0 page 7

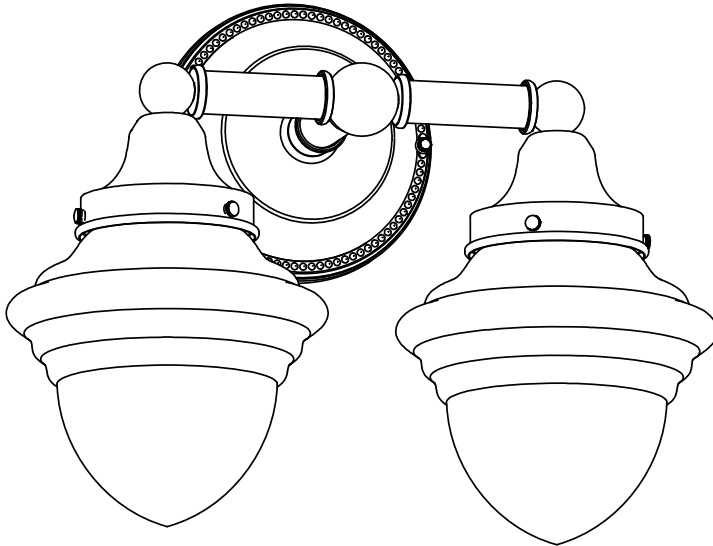

**NEW
CLASSICS**
Handmade in USA

FINISHES - applied by hand.

Polished Nickel	Architectural Bronze
Brushed Nickel	Verdigris Patina
Black	Distressed Brass
Brushed Brass	Antique Copper
Polished Brass	Satin Antique Brass
Antique Nickel	Unlacquered Pol. Brass
Vintage Nickel	Architectural Iron

CN-201-A5 shown with B141 shade

Medium base screw-in sockets (2) each accept 150 W max incandescent, compact fluorescent, or LED.

GU24 base bi-pin socket available. 277V 4 pin socket, inquire.

Check our website for alternative 3-1/4" shades.

Center mount to junction box.

Mount glass up or glass down.

UL listed dry location. Damp location available, inquire.

Durably constructed of solid brass.

Made in USA by Brass Light Gallery.

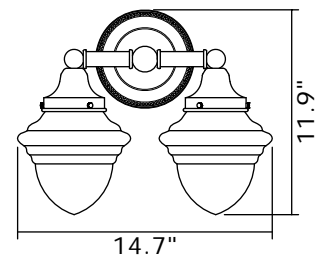
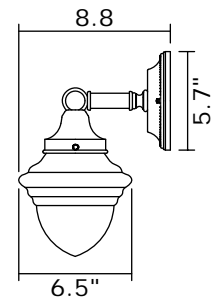

CARLTON™ TWO LIGHT STRAIGHT ARM SCONCE

WITH ELECTRIC CANDLES

brasslightgallery.com 800-243-9595 sales@brasslight.com

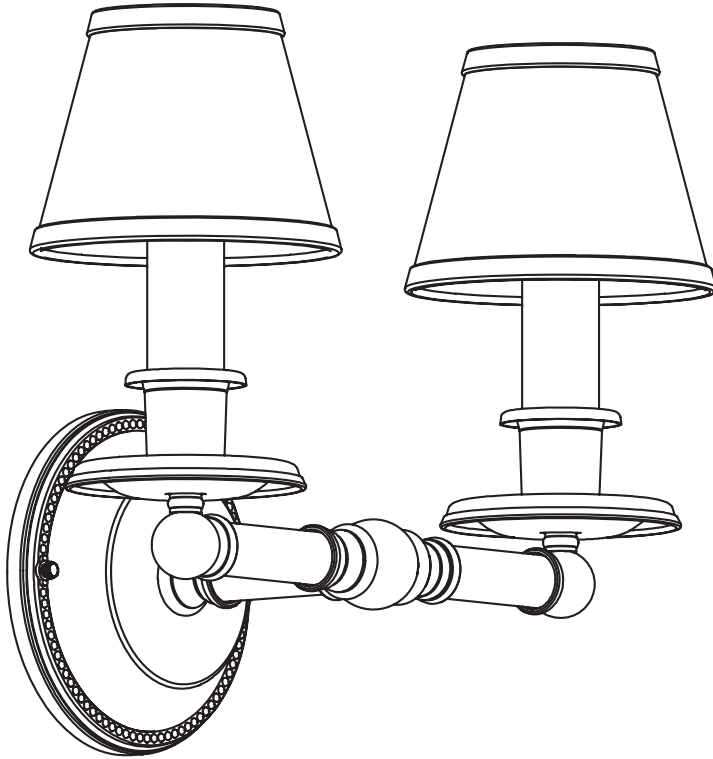

**NEW
CLASSICS**

Handmade in USA

FINISHES - applied by hand.

Polished Nickel	Architectural Bronze
Brushed Nickel	Verdigris Patina
Black	Distressed Brass
Brushed Brass	Antique Copper
Polished Brass	Satin Antique Brass
Antique Nickel	Unlacquered Pol. Brass
Vintage Nickel	Architectural Iron

CN-201-B7 shown with E231 shade

Medium base screw-in sockets (2) each accept 60 W max incandescent, compact fluorescent, or LED.

GU24 base bi-pin socket available. 277V 4 pin socket, inquire.

Check our website for alternative clip-on shades.

Center mount to junction box.

Mount candle up.

UL listed dry location.

Durably constructed of solid brass.

Made in USA by Brass Light Gallery.

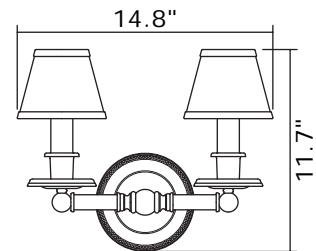
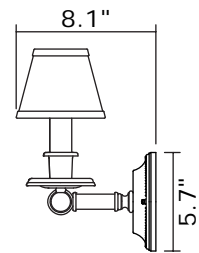

Carlton Family v1.0 page 8

CARLTON™ THREE LIGHT STRAIGHT ARM SCONCE

WITH 2-1/4" SHADE HOLDERS

**NEW
CLASSICS**
Handmade in USA

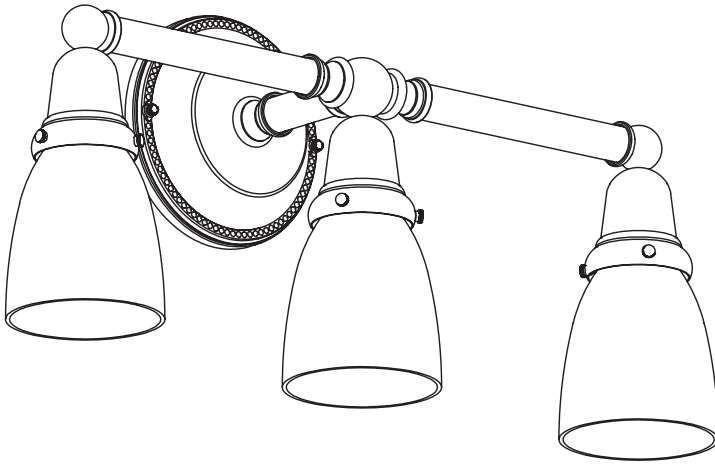

FINISHES - applied by hand.

Polished Nickel	Architectural Bronze
Brushed Nickel	Verdigris Patina
Black	Distressed Brass
Brushed Brass	Antique Copper
Polished Brass	Satin Antique Brass
Antique Nickel	Unlacquered Pol. Brass
Vintage Nickel	Architectural Iron

CN-199-A4 shown with A157 shade

Medium base screw-in sockets (3) each accept 150 W max incandescent, compact fluorescent, or LED.

GU24 base bi-pin socket available. 277V 4 pin socket, inquire.

Check our website for alternative 2-1/4" shades.

Center mount to junction box.

Mount glass up or glass down.

UL listed dry location. Damp location available, inquire.

Durably constructed of solid brass.

Made in USA by Brass Light Gallery.

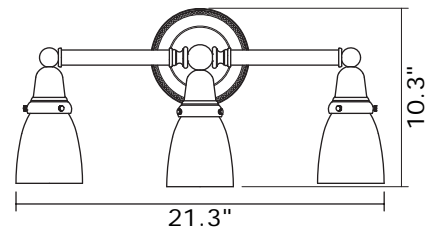
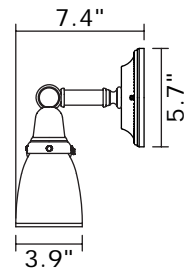

CARLTON™ THREE LIGHT STRAIGHT ARM SCONCE

WITH 3-1/4" SHADE HOLDERS

**NEW
CLASSICS**
Handmade in USA

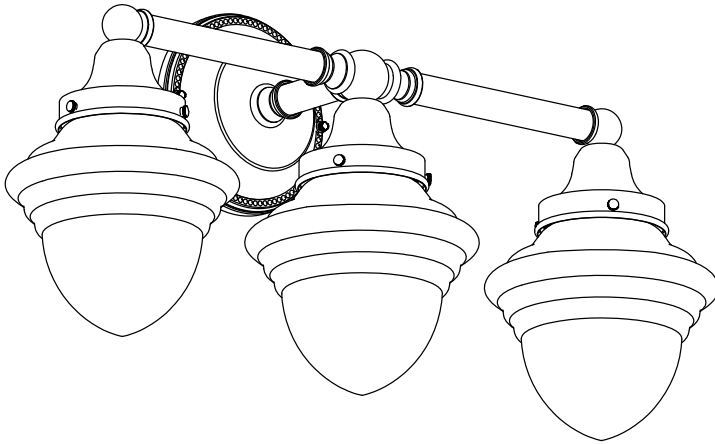

FINISHES - applied by hand.

Polished Nickel	Architectural Bronze
Brushed Nickel	Verdigris Patina
Black	Distressed Brass
Brushed Brass	Antique Copper
Polished Brass	Satin Antique Brass
Antique Nickel	Unlacquered Pol. Brass
Vintage Nickel	Architectural Iron

CN-199-A5 shown with B141 shade

Medium base screw-in sockets (3) each accept 150 W max incandescent, compact fluorescent, or LED.

GU24 base bi-pin socket available. 277V 4 pin socket, inquire.

Check our website for alternative 3-1/4" shades.

Center mount to junction box.

Mount glass up or glass down.

UL listed dry location. Damp location available, inquire.

Durably constructed of solid brass.

Made in USA by Brass Light Gallery.

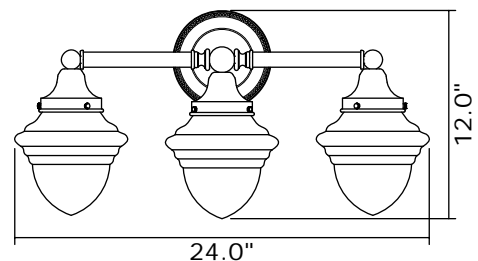
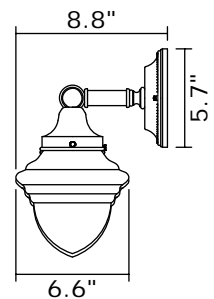

CARLTON™ ONE LIGHT CURVED ARM SCONCE

WITH 2-1/4" SHADE HOLDER

brasslightgallery.com 800-243-9595 sales@brasslight.com

Carlton Family v1.0 page 11

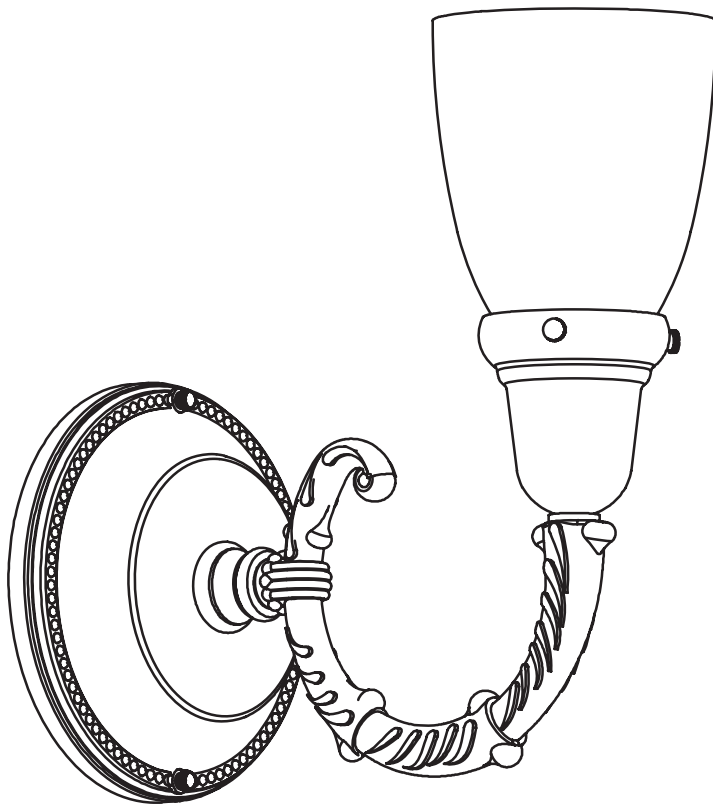

**NEW
CLASSICS**
Handmade in USA

FINISHES - applied by hand.

Polished Nickel	Architectural Bronze
Brushed Nickel	Verdigris Patina
Black	Distressed Brass
Brushed Brass	Antique Copper
Polished Brass	Satin Antique Brass
Antique Nickel	Unlacquered Pol. Brass
Vintage Nickel	Architectural Iron

CN-202-A4 shown with A157 shade

Medium base screw-in socket (1) accepts 150 W max incandescent, compact fluorescent, or LED.

GU24 base bi-pin socket available. 277V 4 pin socket, inquire.

Check our website for alternative 2-1/4" shades.

Center mount to junction box.

Mount glass up or glass down.

UL listed dry location. Damp location available, inquire.

Durably constructed of solid brass.

Made in USA by Brass Light Gallery.

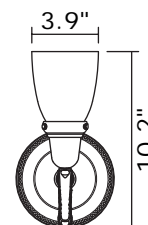
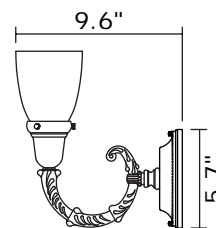

CARLTON™ ONE LIGHT CURVED ARM SCONCE

WITH 3-1/4" SHADE HOLDER

brasslightgallery.com 800-243-9595 sales@brasslight.com

Carlton Family v1.0 page 12

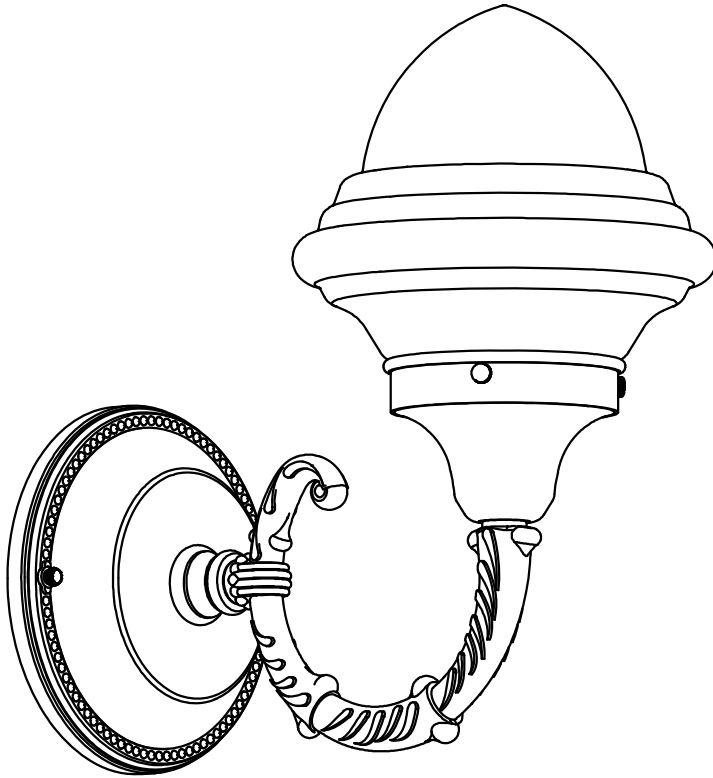

**NEW
CLASSICS**
Handmade in USA

FINISHES - applied by hand.

Polished Nickel	Architectural Bronze
Brushed Nickel	Verdigris Patina
Black	Distressed Brass
Brushed Brass	Antique Copper
Polished Brass	Satin Antique Brass
Antique Nickel	Unlacquered Pol. Brass
Vintage Nickel	Architectural Iron

CN-202-A5 shown with B141 shade

Medium base screw-in socket (1) accepts 150 W max incandescent, compact fluorescent, or LED.

GU24 base bi-pin socket available. 277V 4 pin socket, inquire.

Check our website for alternative 3-1/4" shades.

Center mount to junction box.

Mount glass up or glass down.

UL listed dry location. Damp location available, inquire.

Durably constructed of solid brass.

Made in USA by Brass Light Gallery.

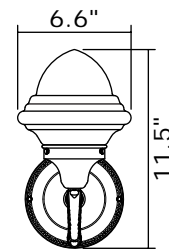
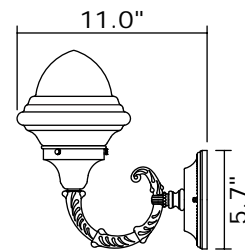

CARLTON™ ONE LIGHT CURVED ARM SCONCE

WITH ELECTRIC CANDLE

brasslightgallery.com 800-243-9595 sales@brasslight.com

Carlton Family v1.0 page 13

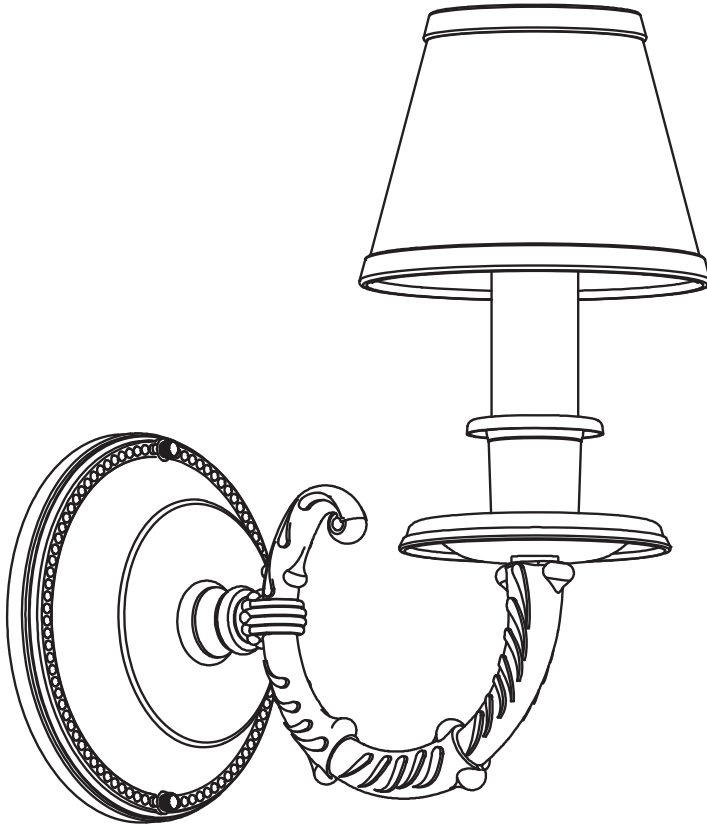

**NEW
CLASSICS**
Handmade in USA

FINISHES - applied by hand.

Polished Nickel	Architectural Bronze
Brushed Nickel	Verdigris Patina
Black	Distressed Brass
Brushed Brass	Antique Copper
Polished Brass	Satin Antique Brass
Antique Nickel	Unlacquered Pol. Brass
Vintage Nickel	Architectural Iron

CN-202-B7 shown with E231 shade

Medium base screw-in socket (1) accepts 60 W max incandescent, compact fluorescent, or LED.

GU24 base bi-pin socket available. 277V 4 pin socket, inquire.

Check our website for alternative clip-on shades.

Center mount to junction box.

Mount candle up.

UL listed dry location.

Durably constructed of solid brass.

Made in USA by Brass Light Gallery.

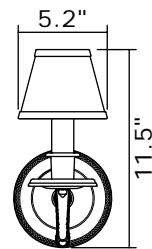
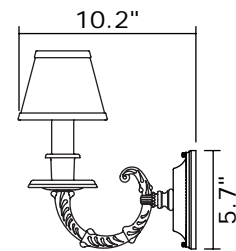

CARLTON™ ONE LIGHT TORCH SCONCE

WITH 2-1/4" SHADE HOLDER

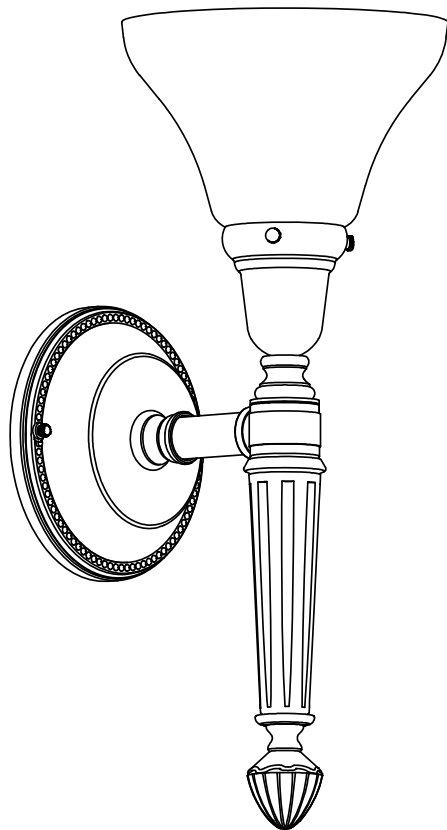

**NEW
CLASSICS**
Handmade in USA

FINISHES - applied by hand.

Polished Nickel	Architectural Bronze
Brushed Nickel	Verdigris Patina
Black	Distressed Brass
Brushed Brass	Antique Copper
Polished Brass	Satin Antique Brass
Antique Nickel	Unlacquered Pol. Brass
Vintage Nickel	Architectural Iron

CN-210-A4 shown with A154 shade

Medium base screw-in socket (1) accepts 150 W max incandescent, compact fluorescent, or LED.

GU24 base bi-pin socket available. 277V 4 pin socket, inquire.

Check our website for alternative 2-1/4" shades.

Center mount to junction box.

Mount up only.

UL listed dry location. Damp location available, inquire.

Durably constructed of solid brass.

Made in USA by Brass Light Gallery.

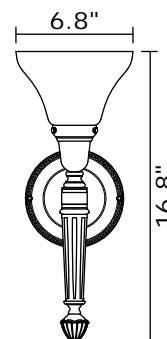
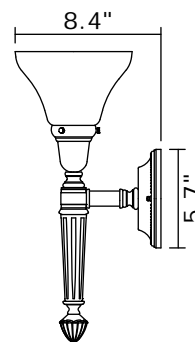

CARLTON™ ONE LIGHT TORCH SCONCE

WITH 3-1/4" SHADE HOLDER

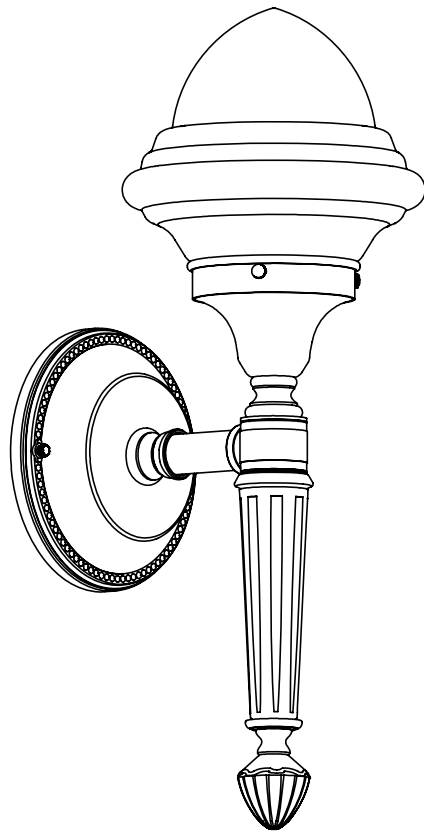

**NEW
CLASSICS**
Handmade in USA

FINISHES - applied by hand.

Polished Nickel	Architectural Bronze
Brushed Nickel	Verdigris Patina
Black	Distressed Brass
Brushed Brass	Antique Copper
Polished Brass	Satin Antique Brass
Antique Nickel	Unlacquered Pol. Brass
Vintage Nickel	Architectural Iron

CN-210-A5 shown with B311 shade

Medium base screw-in socket (1) accepts 150 W max incandescent, compact fluorescent, or LED.

GU24 base bi-pin socket available. 277V 4 pin socket, inquire.

Check our website for alternative 3-1/4" shades.

Center mount to junction box.

Mount up only.

UL listed dry location. Damp location available, inquire.

Durably constructed of solid brass.

Made in USA by Brass Light Gallery.

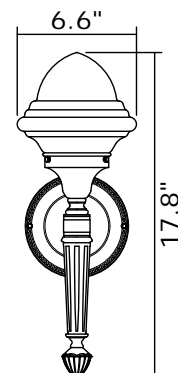
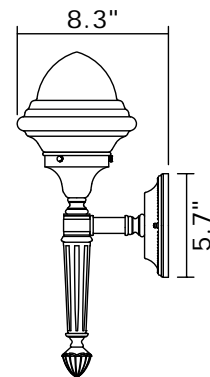

CARLTON™ ONE LIGHT TORCH SCONCE

WITH ELECTRIC CANDLE

brasslightgallery.com 800-243-9595 sales@brasslight.com

Carlton Family v1.0 page 16

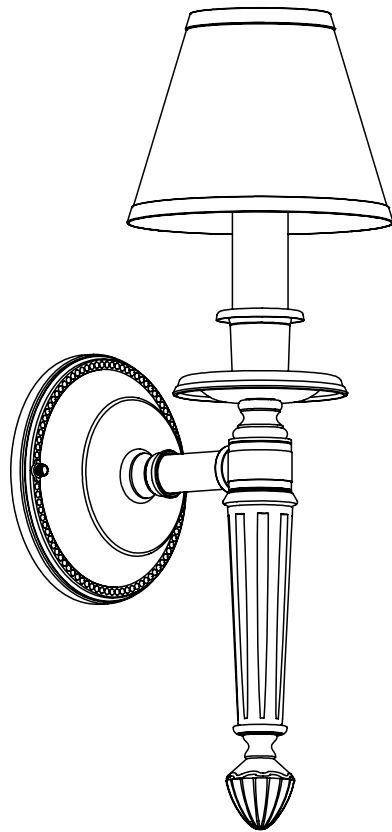

**NEW
CLASSICS**
Handmade in USA

FINISHES - applied by hand.

Polished Nickel	Architectural Bronze
Brushed Nickel	Verdigris Patina
Black	Distressed Brass
Brushed Brass	Antique Copper
Polished Brass	Satin Antique Brass
Antique Nickel	Unlacquered Pol. Brass
Vintage Nickel	Architectural Iron

CN-210-B7 shown with E244 shade

Medium base screw-in socket (1) accepts 60 W max incandescent, compact fluorescent, or LED.

GU24 base bi-pin socket available. 277V 4 pin socket, inquire.

Check our website for alternative clip-on shades.

Center mount to junction box.

Mount candle up.

UL listed dry location.

Durably constructed of solid brass.

Made in USA by Brass Light Gallery.

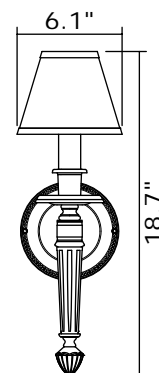
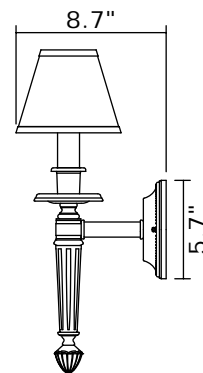

CARLTON™ ONE LIGHT SEMI FLUSH CEILING FIXTURE

WITH 2-1/4" SHADE HOLDER

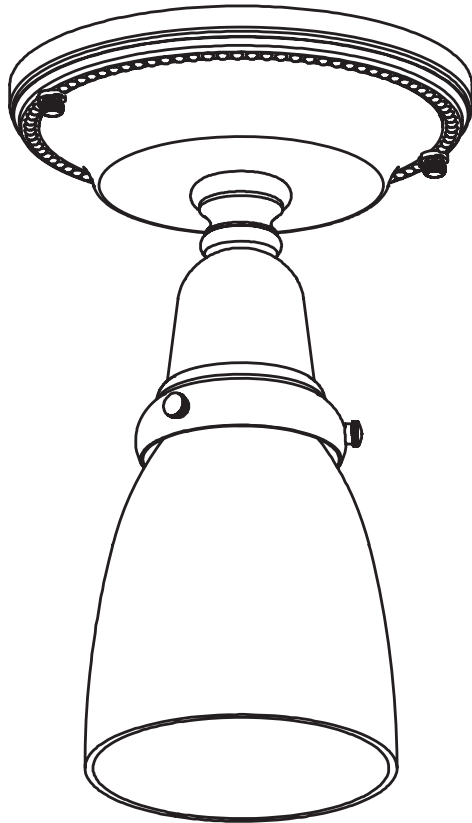

**NEW
CLASSICS**
Handmade in USA

FINISHES - applied by hand.

Polished Nickel	Architectural Bronze
Brushed Nickel	Verdigris Patina
Black	Distressed Brass
Brushed Brass	Antique Copper
Polished Brass	Satin Antique Brass
Antique Nickel	Unlacquered Pol. Brass
Vintage Nickel	Architectural Iron

CN-403-A4-01M shown with A157 shade

Medium base screw-in socket (1) accepts 150 W max incandescent, compact fluorescent, or LED.

GU24 base bi-pin socket available. 277V 4 pin socket, inquire.

Check our website for alternative 2-1/4" shades.

Center mount to junction box.

Angled ceiling version available, inquire.

UL listed dry location. Damp location available, inquire.

Durably constructed of solid brass.

Made in USA by Brass Light Gallery.

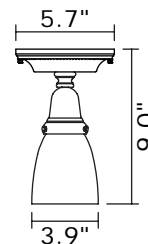

CARLTON™ ONE LIGHT SEMI FLUSH CEILING FIXTURE

WITH 3-1/4" SHADE HOLDER

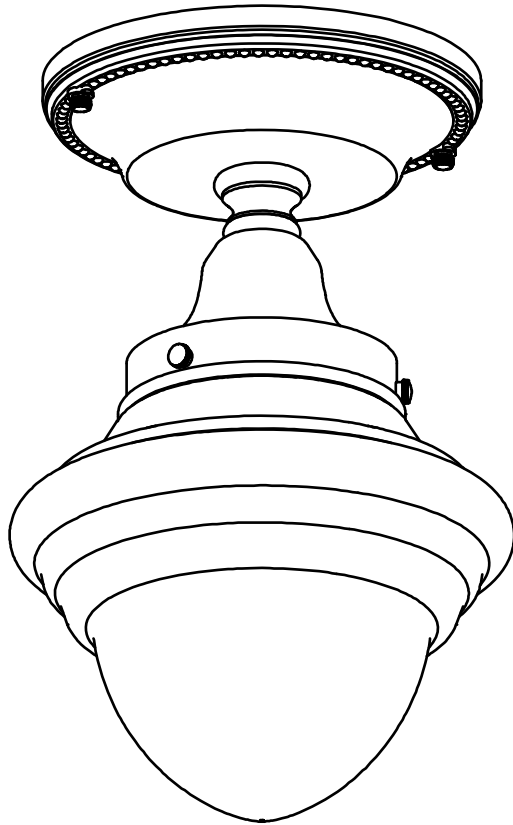

**NEW
CLASSICS**
Handmade in USA

FINISHES - applied by hand.

Polished Nickel	Architectural Bronze
Brushed Nickel	Verdigris Patina
Black	Distressed Brass
Brushed Brass	Antique Copper
Polished Brass	Satin Antique Brass
Antique Nickel	Unlacquered Pol. Brass
Vintage Nickel	Architectural Iron

CN-403-A5-01M shown with B141 shade

Medium base screw-in socket (1) accepts 150 W max incandescent, compact fluorescent, or LED.

GU24 base bi-pin socket available. 277V 4 pin socket, inquire.

Check our website for alternative 3-1/4" shades.

Center mount to junction box.

Angled ceiling version available, inquire.

UL listed dry location. Damp location available, inquire.

Durably constructed of solid brass.

Made in USA by Brass Light Gallery.

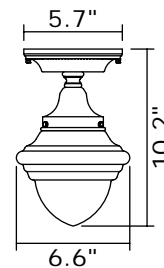

CARLTON™ ONE LIGHT SEMI FLUSH CEILING FIXTURE

WITH 4-1/4" SHADE HOLDER

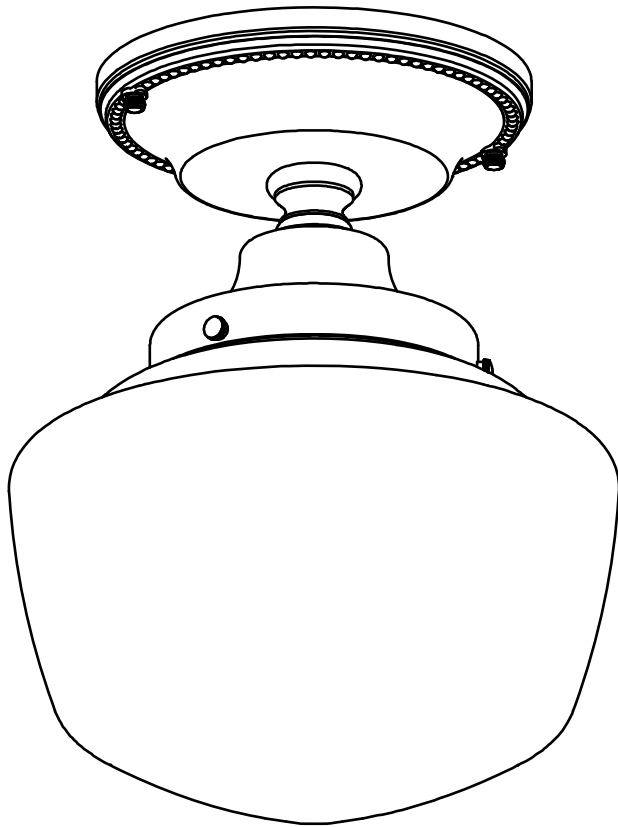

**NEW
CLASSICS**
Handmade in USA

FINISHES - applied by hand.

Polished Nickel	Architectural Bronze
Brushed Nickel	Verdigris Patina
Black	Distressed Brass
Brushed Brass	Antique Copper
Polished Brass	Satin Antique Brass
Antique Nickel	Unlacquered Pol. Brass
Vintage Nickel	Architectural Iron

CN-403-A6-01M shown with C300 shade

Medium base screw-in socket (1) accepts 150 W max incandescent, compact fluorescent, or LED.

GU24 base bi-pin socket available. 277V 4 pin socket, inquire.

Check our website for alternative 4-1/4" shades.

Center mount to junction box.

Angled ceiling version available, inquire.

UL listed dry location. Damp location available, inquire.

Durably constructed of solid brass.

Made in USA by Brass Light Gallery.

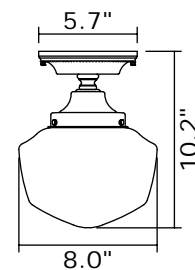

CARLTON™ ONE LIGHT SEMI FLUSH CEILING FIXTURE

WITH 6-1/4" SHADE HOLDER

brasslightgallery.com 800-243-9595 sales@brasslight.com

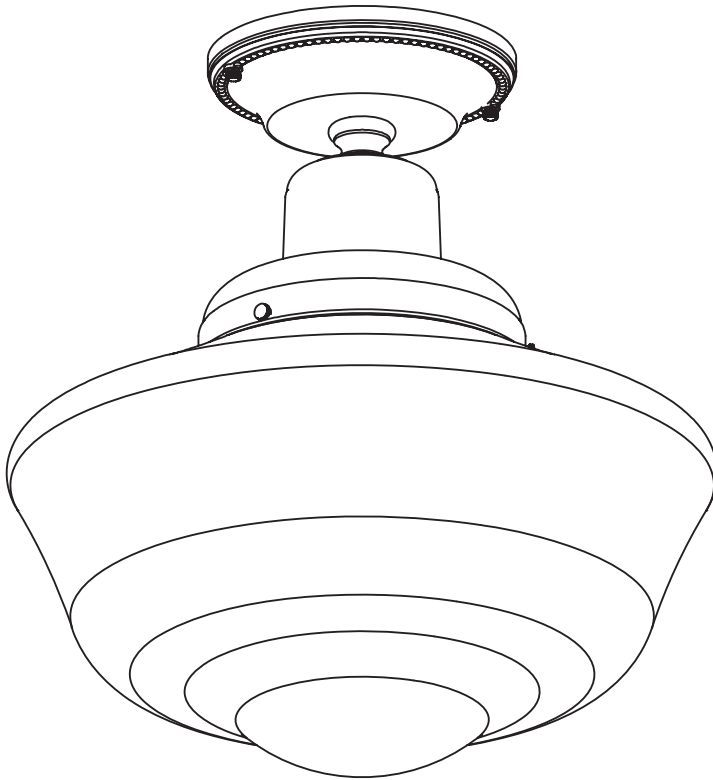

**NEW
CLASSICS**
Handmade in USA

FINISHES - applied by hand.

Polished Nickel	Architectural Bronze
Brushed Nickel	Verdigris Patina
Black	Distressed Brass
Brushed Brass	Antique Copper
Polished Brass	Satin Antique Brass
Antique Nickel	Unlacquered Pol. Brass
Vintage Nickel	Architectural Iron

CN-403-A8-01M shown with D303 shade

Medium base screw-in socket (1) accepts 150 W max incandescent, compact fluorescent, or LED.

GU24 base bi-pin socket available. 277V 4 pin socket, inquire.

Alternative 6-1/4" shades are available.

Center mount to junction box.

Angled ceiling version available, inquire.

UL listed dry location. Damp location available, inquire.

Durably constructed of solid brass.

Made in USA by Brass Light Gallery.

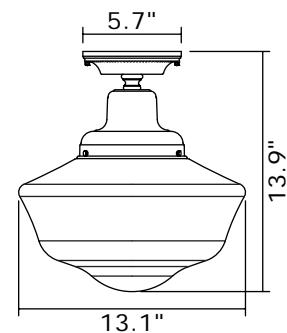

Carlton Family v1.0 page 20

BRASS LIGHT GALLERY
• MILWAUKEE •

© 2012, Brass Light Gallery®

CARLTON™ ONE LIGHT PENDANT

WITH 2-1/4" SHADE HOLDER

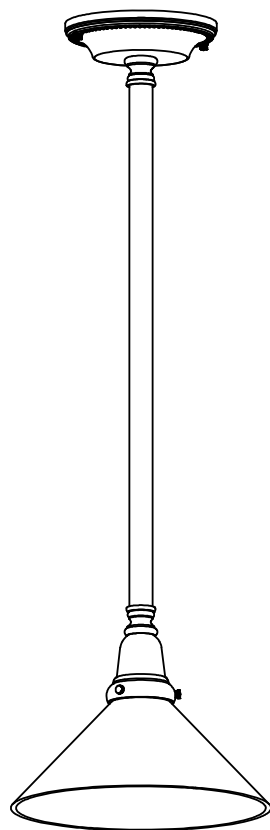

**NEW
CLASSICS**
Handmade in USA

FINISHES - applied by hand.

Polished Nickel	Architectural Bronze
Brushed Nickel	Verdigris Patina
Black	Distressed Brass
Brushed Brass	Antique Copper
Polished Brass	Satin Antique Brass
Antique Nickel	Unlacquered Pol. Brass
Vintage Nickel	Architectural Iron

CN-415-A4-03M shown with A384 shade

Medium base screw-in socket (1) accepts 150 W max incandescent, compact fluorescent, or LED.

GU24 base bi-pin socket available. 277V 4 pin socket, inquire.

Check our website for alternative 2-1/4" shades.

Center mount to junction box.

Specify overall length. Minimum overall length 11".

Angled ceiling version available, inquire.

UL listed dry location. Damp location available, inquire.

Durably constructed of solid brass.

Made in USA by Brass Light Gallery.



CARLTON™ ONE LIGHT PENDANT

WITH 3-1/4" SHADE HOLDER

brasslightgallery.com 800-243-9595 sales@brasslight.com

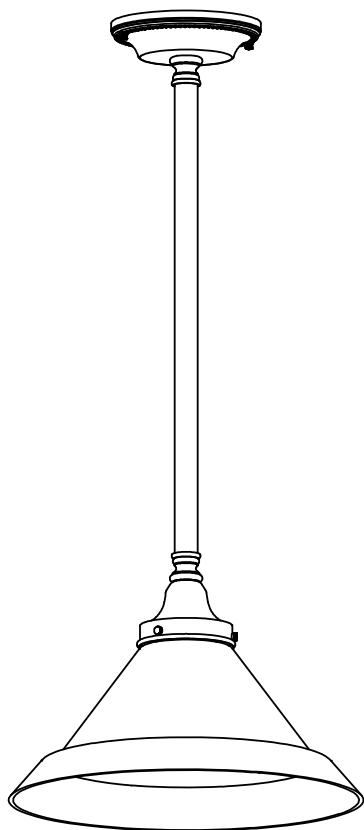

**NEW
CLASSICS**
Handmade in USA

FINISHES - applied by hand.

Polished Nickel	Architectural Bronze
Brushed Nickel	Verdigris Patina
Black	Distressed Brass
Brushed Brass	Antique Copper
Polished Brass	Satin Antique Brass
Antique Nickel	Unlacquered Pol. Brass
Vintage Nickel	Architectural Iron

CN-415-A5-03M shown with B409 shade

Medium base screw-in socket (1) accepts 150 W max incandescent, compact fluorescent, or LED.

GU24 base bi-pin socket available. 277V 4 pin socket, inquire.

Check our website for alternative 3-1/4" shades.

Center mount to junction box.

Specify overall length. Minimum overall length 11".

Angled ceiling version available, inquire.

UL listed dry location. Damp location available, inquire.

Durably constructed of solid brass.

Made in USA by Brass Light Gallery.

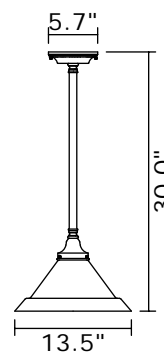

Carlton Family v1.0 page 22

BRASS LIGHT GALLERY
• MILWAUKEE •

© 2012, Brass Light Gallery®

CARLTON™ ONE LIGHT PENDANT

WITH 4-1/4" SHADE HOLDER

brasslightgallery.com 800-243-9595 sales@brasslight.com

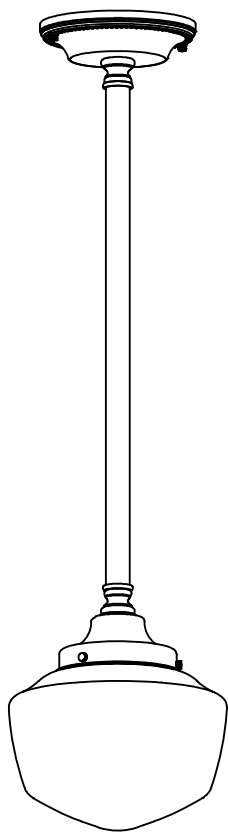

**NEW
CLASSICS**
Handmade in USA

FINISHES - applied by hand.

Polished Nickel	Architectural Bronze
Brushed Nickel	Verdigris Patina
Black	Distressed Brass
Brushed Brass	Antique Copper
Polished Brass	Satin Antique Brass
Antique Nickel	Unlacquered Pol. Brass
Vintage Nickel	Architectural Iron

CN-415-A6-03M shown with C300 shade

Medium base screw-in socket (1) accepts 150 W max incandescent, compact fluorescent, or LED.

GU24 base bi-pin socket available. 277V 4 pin socket, inquire.

Check our website for alternative 4-1/4" shades.

Center mount to junction box.

Specify overall length. Minimum overall length 13".

Angled ceiling version available, inquire.

UL listed dry location. Damp location available, inquire.

Durably constructed of solid brass.

Made in USA by Brass Light Gallery.

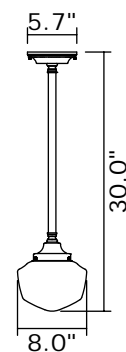

Carlton Family v1.0 page 23

BRASS LIGHT GALLERY
• MILWAUKEE •

© 2012, Brass Light Gallery®

CARLTON™ ONE LIGHT PENDANT

WITH 6-1/4" SHADE HOLDER

brasslightgallery.com 800-243-9595 sales@brasslight.com

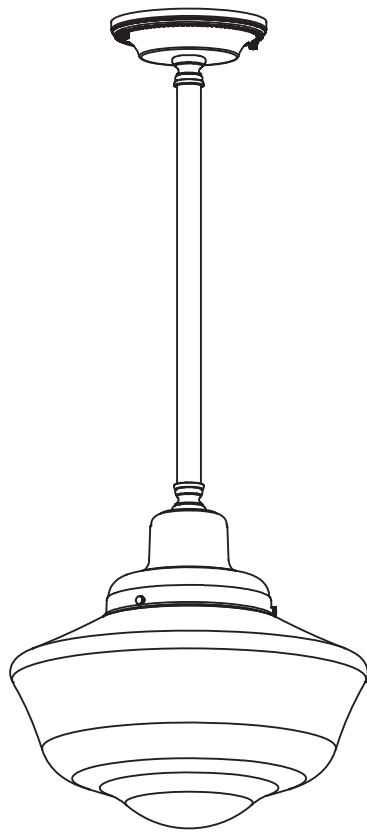

**NEW
CLASSICS**
Handmade in USA

FINISHES - applied by hand.

Polished Nickel	Architectural Bronze
Brushed Nickel	Verdigris Patina
Black	Distressed Brass
Brushed Brass	Antique Copper
Polished Brass	Satin Antique Brass
Antique Nickel	Unlacquered Pol. Brass
Vintage Nickel	Architectural Iron

CN-415-A8-03M shown with D303 shade

Medium base screw-in socket (1) accepts 150 W max incandescent, compact fluorescent, or LED.

GU24 base bi-pin socket available. 277V 4 pin socket, inquire.

Check our website for alternative 6-1/4" shades.

Center mount to junction box.

Specify overall length. Minimum overall length 14".

Angled ceiling version available, inquire.

UL listed dry location. Damp location available, inquire.

Durably constructed of solid brass.

Made in USA by Brass Light Gallery.

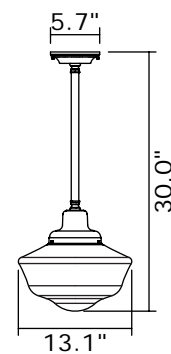

Carlton Family v1.0 page 24

BRASS LIGHT GALLERY
• MILWAUKEE •

© 2012, Brass Light Gallery®

CARLTON™ FLUSH CEILING FIXTURE

brasslightgallery.com 800-243-9595 sales@brasslight.com

Carlton Family v1.0 page 25

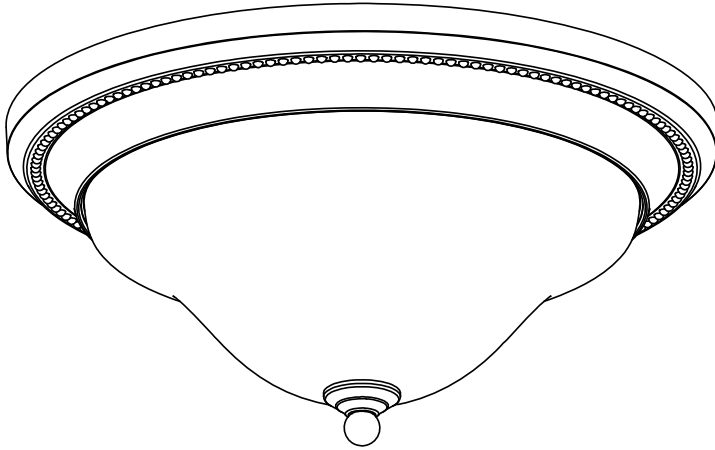

**NEW
CLASSICS**
Handmade in USA

FINISHES - applied by hand.

Polished Nickel	Architectural Bronze
Brushed Nickel	Verdigris Patina
Black	Distressed Brass
Brushed Brass	Antique Copper
Polished Brass	Satin Antique Brass
Antique Nickel	Unlacquered Pol. Brass
Vintage Nickel	Architectural Iron

CN-419-01M

Candelabra base screw-in sockets (2) each accept 60 W max incandescent, compact fluorescent, or LED.

GU24 base bi-pin socket available. 277V 4 pin socket, inquire.

Center mount to junction box.

UL listed dry location. Damp location available, inquire.

Durably constructed of solid brass.

Made in USA by Brass Light Gallery.

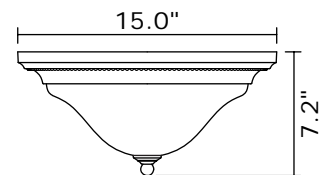

CARLTON™ TWO LIGHT SEMI FLUSH CEILING FIXTURE

WITH 2-1/4" SHADE HOLDERS

**NEW
CLASSICS**
Handmade in USA

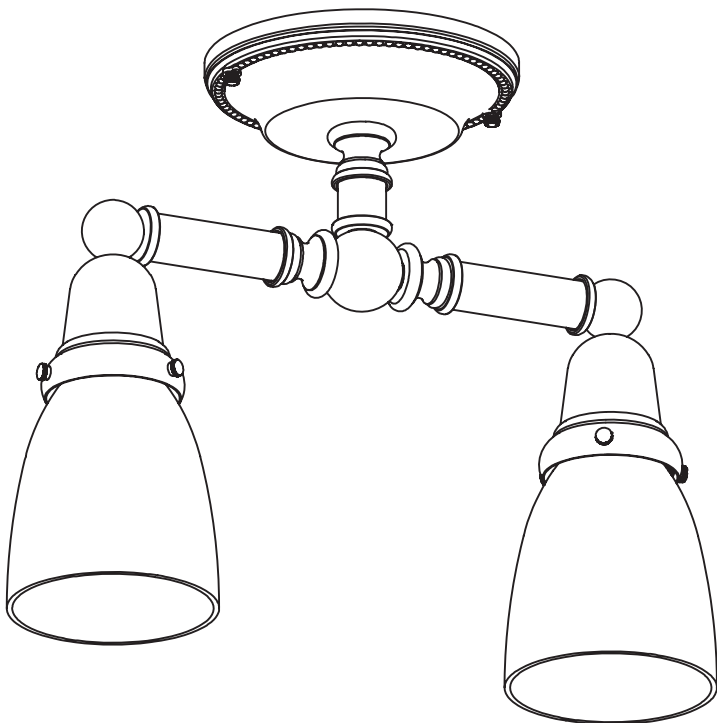

FINISHES - applied by hand.

Polished Nickel	Architectural Bronze
Brushed Nickel	Verdigris Patina
Black	Distressed Brass
Brushed Brass	Antique Copper
Polished Brass	Satin Antique Brass
Antique Nickel	Unlacquered Pol. Brass
Vintage Nickel	Architectural Iron

CN-433-A4-03M shown with A157 shade

Medium base screw-in sockets (2) each accept 150 W max incandescent, compact fluorescent, or LED.

GU24 base bi-pin socket available. 277V 4 pin socket, inquire.

Check our website for alternative 2-1/4" shades.

Center mount to junction box.

UL listed dry location. Damp location available, inquire.

Durably constructed of solid brass.

Made in USA by Brass Light Gallery.

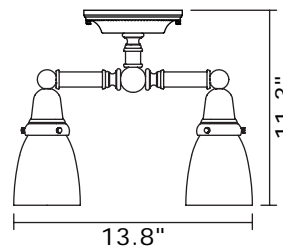
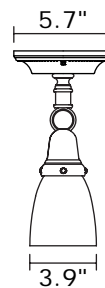

CARLTON™ TWO LIGHT SEMI FLUSH CEILING FIXTURE

WITH 3-1/4" SHADE HOLDERS

brasslightgallery.com 800-243-9595 sales@brasslight.com

Carlton Family v1.0 page 27

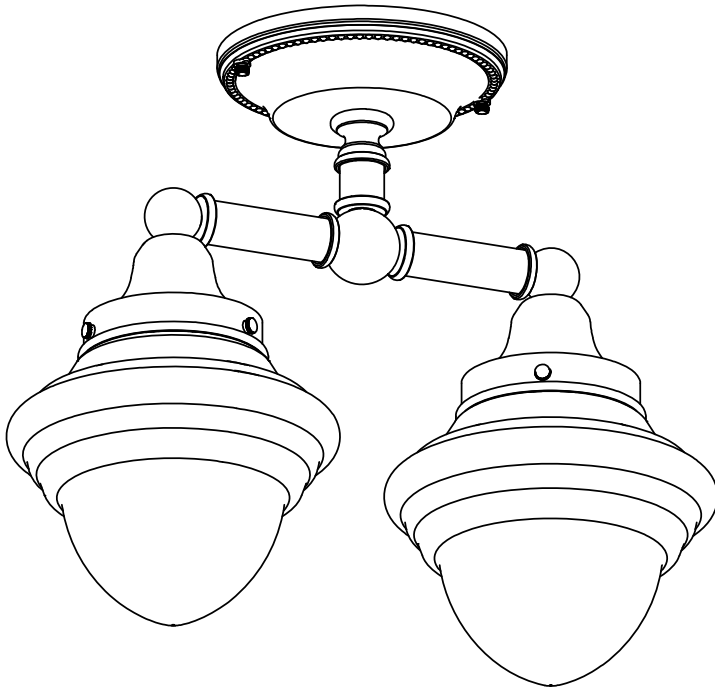

**NEW
CLASSICS**
Handmade in USA

FINISHES - applied by hand.

Polished Nickel	Architectural Bronze
Brushed Nickel	Verdigris Patina
Black	Distressed Brass
Brushed Brass	Antique Copper
Polished Brass	Satin Antique Brass
Antique Nickel	Unlacquered Pol. Brass
Vintage Nickel	Architectural Iron

CN-433-A5-03M shown with B141 shade

Medium base screw-in sockets (2) each accept 150 W max incandescent, compact fluorescent, or LED.

GU24 base bi-pin socket available. 277V 4 pin socket, inquire.

Check our website for alternative 3-1/4" shades.

Center mount to junction box.

UL listed dry location. Damp location available, inquire.

Durably constructed of solid brass.

Made in USA by Brass Light Gallery.

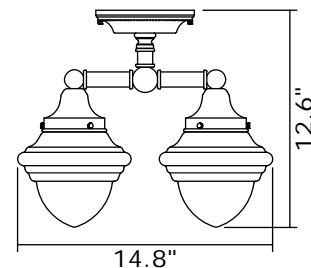
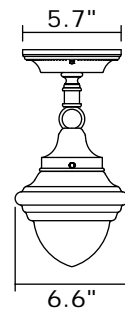

CARLTON™ SIX LIGHT CHANDELIER

WITH ELECTRIC CANDLES

brasslightgallery.com 800-243-9595 sales@brasslight.com

Carlton Family v1.0 page 28

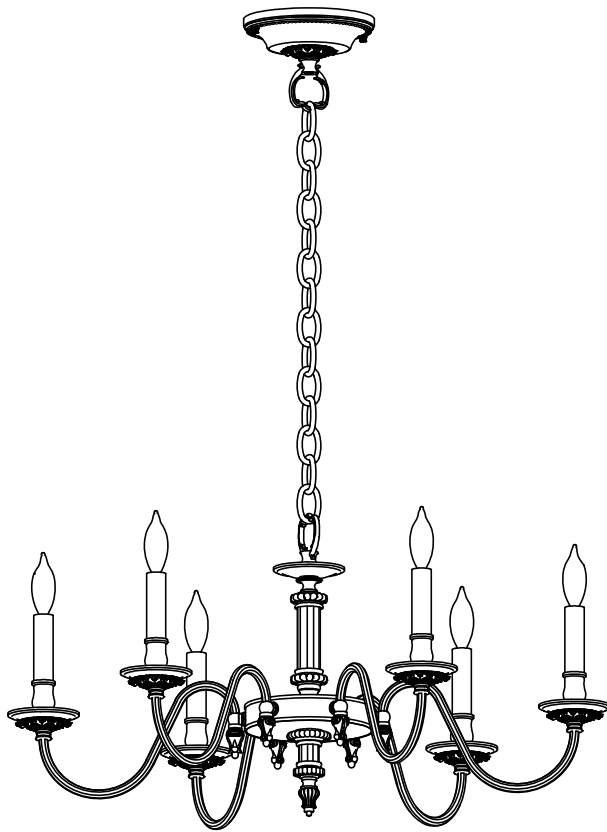

**NEW
CLASSICS**
Handmade in USA

FINISHES - applied by hand.

Polished Nickel	Architectural Bronze
Brushed Nickel	Verdigris Patina
Black	Distressed Brass
Brushed Brass	Antique Copper
Polished Brass	Satin Antique Brass
Antique Nickel	Unlacquered Pol. Brass
Vintage Nickel	Architectural Iron

CN-481-E2-05M

Candelabra base screw-in sockets (6) each accept 60 W max incandescent, compact fluorescent, or LED.

GU24 base bi-pin socket available. 277V 4 pin socket, inquire.

Check our website for alternative clip-on shades.

Center mount to junction box.

Specify overall length. Minimum overall length 18".

UL listed dry location.

Durably constructed of solid brass.

Made in USA by Brass Light Gallery.

